

# Coordination tables

1SDC007004D0204



---

# Coordination tables

## Index

---

Introduction .....	I
Back-up .....	1/1
Discrimination .....	2/1
Motor protection .....	3/1
Switch-disconnectors .....	4/1

---

# Coordination tables

## Introduction

---

Discrimination and back-up .....	II
Choosing the type of coordination for protection of a low voltage installation .....	II
Types of coordination .....	III
General notes on switching and protection of motors .....	VIII
Electromechanical starter .....	VIII
Starting methods .....	IX
Switch-disconnectors .....	XII

---

# Coordination tables

## Discrimination and back-up

---

This collection of selectivity and back-up tables for ABB circuit-breakers has been studied to help select the appropriate circuit-breaker, fulfilling the specific selectivity and back-up requirements according to the different types of installation.

The tables are divided on the basis of the type of intervention (back-up or selective protection), and are grouped according to types of circuit-breakers (air, moulded-case, and miniature), covering all the possible combinations of ABB circuit-breakers.

The technical data, updated to the latest series of miniature, moulded-case and air circuit breakers on the market, make this publication a comprehensive and simple tool: once again, ABB SACE makes its consolidated experience in the Low Voltage sector available to professionals.

### Choosing the type of coordination for protection of a low voltage installation

#### Problems and requirements for coordinating protection devices

Selection of the system for protecting an electric installation is of paramount importance both to ensure correct economic and functional operation of the whole installation and to reduce any problems caused by anomalous operating conditions and actual faults to a minimum.

This analysis deals with coordination between the different devices dedicated to protection of zones and specific components in order to:

- guarantee safety for people and the installation at all times;
- identify and rapidly exclude only the zone affected by a given problem, instead of taking indiscriminate action thereby reducing the energy available in areas unaffected by the fault;
- reduce the effects of a fault on other sound parts of the installation (voltage drops, loss of stability in rotating machines);
- reduce the stress on components and damage in the zone involved;
- ensure service continuity with good quality power supply voltage;
- guarantee adequate backup in the event of any malfunction of the protection device responsible for opening the circuit;
- provide maintenance personnel and the management system with the information needed to restore the service as rapidly as possible and with minimal disturbance to the rest of the network;
- achieve a valid compromise between reliability, simplicity and cost effectiveness.

To be more precise, a valid protection system must be able to:

- understand what and where an event has occurred, discriminating between situations that are anomalous but tolerable and genuine faults within a given zone of influence, avoiding unwarranted trips which lead to unjustified stoppage of a sound part of the installation;
- act as rapidly as possible to limit damage (destruction, accelerated ageing, etc.), safeguarding continuity and stability of the power supply.

The solutions stem from a compromise between the following two opposing needs - precise identification of the fault and rapid intervention - and are defined according to which requirement takes priority.

For instance, when it is more important to avoid unnecessary tripping, it is generally preferable to have an indirect protection system based on interlocks and data transmission between different devices which measure the electrical values locally, whereas for prompt response and limitation of the destructive effect of short-circuits, a direct-acting system with releases integrated in the devices is needed. Generally speaking, in low voltage systems for primary and secondary distribution, the latter solution is preferable.

---

## Coordination tables

### Discrimination and back-up

---

Restricting the field to an analysis of the problem of how to harmonize the action of the protection devices in the event of overcurrents (overloads and short-circuits) - a problem covering 90% of the coordination requirements of protection devices in radial low voltage installations - it is important to remember that:

- **overcurrent trip selectivity** means “coordination of the operating characteristics of two or more overcurrent protection devices so that, on occurrence of overcurrents within established limits, the device supposed to operate within these limits intervenes, whereas the others do not”<sup>1</sup>;
- **total discrimination** means “overcurrent selectivity so that when there are two overcurrent protection devices in series, the protection device on the load side provides protection without tripping the other protection device”<sup>2</sup>;
- **partial discrimination** means “overcurrent selectivity so that when there are two overcurrent protection devices in series, the protection device on the load side provides protection up to a given overcurrent limit without tripping the other device”<sup>3</sup>. This overcurrent threshold is called the “selectivity limit current  $I_s$ ”<sup>4</sup>;
- **back-up protection** means “coordination for protection against overcurrents of two protection devices in series, where the protection device generally (but not necessarily) situated on the supply side provides overcurrent protection with or without the aid of the other protection device and avoids excessive stress on the latter”<sup>5</sup>. The current value above which protection is ensured is called the “switching current  $I_B$ ”<sup>6</sup>.

#### Types of coordination

##### Influence of the electrical parameters of the installation (rated current and short-circuit current)

If the analysis is restricted to the behaviour of the protection devices with tripping based on overcurrent releases, the strategy used to coordinate the protection devices mainly depends on the rated current ( $I_n$ ) and short-circuit current ( $I_k$ ) values in the part of installation concerned.

Generally speaking, the following types of coordination can be classified:

- current type selectivity;
- time type selectivity;
- zone selectivity;
- energy selectivity;
- back-up.

Now let us examine these various solutions in detail.

---

<sup>1</sup> IEC 60947-1 Standard, def. 2.5.23

<sup>2</sup> IEC 60947-2 Standard, def. 2.17.2

<sup>3</sup> IEC 60947-2 Standard, def. 2.17.3

<sup>4</sup> IEC 60947-2 Standard, def. 2.17.4

<sup>5</sup> IEC 60947-1 Standard, def. 2.5.24

<sup>6</sup> IEC 60947-1 Standard, def. 2.5.25 and IEC 60947-1 Standard, def. 2.17.6

---

## Coordination tables

### Discrimination and back-up

---

#### Current type selectivity

This type of discrimination is based on the observation that the closer the fault is to the power supply of the installation, the higher the short-circuit current will be. We can therefore pinpoint the zone where the fault has occurred can therefore be discriminated simply by setting the protection devices to a limit value so that this does not generate unwarranted trips due to faults in the zone of influence of the protection device immediately to the load side (where the fault current must be lower than the current threshold set on the protection device on the supply side).

Total discrimination can normally only be obtained in specific cases where the fault current is not very high or where a component with high impedance is placed between the two protection devices (e.g. a transformer, a very long cable, or a cable with reduced cross-section, etc.) giving rise to a great difference between the short-circuit current values.

This type of coordination is therefore mainly used in end distribution (with low rated current and short-circuit current values and high impedance of the connection cables). The device time-current trip curves are generally used for the study.

This solution is intrinsically rapid (instantaneous), easy to implement and inexpensive. On the other hand:

- the selectivity limit current is normally low, so discrimination is often only partial;
- the threshold setting of the overcurrent protection devices rapidly exceeds the values consistent with safety requirements, becoming incompatible with the need to reduce damage caused by short-circuits;
- it becomes impossible to provide redundant protection devices which can guarantee elimination of the fault in the event of any of the protection devices failing to function.

#### Time type selectivity

This type of discrimination is an evolution of the previous one. Using this type of coordination, in order to define the trip threshold, the current value measured is associated with the duration of the phenomenon: a given current value will trip the protection devices after an established time delay, which is such as to allow any protection devices situated closer to the fault to trip, excluding the zone where the fault occurred.

The setting strategy is therefore to progressively increase the current thresholds and the trip time delays the closer one is to the power supply source (the setting level correlates directly with the hierarchical level). The steps between the time delays set on protection devices in series must take into account the sum of the times for detecting and eliminating the fault and the overshoot time of the supply side device (the time interval during which the protection device can trip even if the phenomenon has already ended). As in the case of current type selectivity, the study is carried out by comparing the time-current protection device trip curves.

This type of coordination is generally:

- easy to study and implement, and inexpensive with regard to the protection system;
- it allows even high limit discrimination levels to be obtained, depending on the shorttime withstand current of the supply side device;
- it allows redundant protection functions and can send valid information to the control system;

but:

- the trip times and energy levels let through by the protection devices, especially those close to the sources, are high, with obvious problems regarding safety and damage to the components (often oversized) even in zones unaffected by the fault;
- it only allows use of current-limiting circuit-breakers at levels hierarchically lower down the chain. The other circuit-breakers must be capable of withstanding the thermal and electro-dynamic stresses related to the passage of the fault current for the intentional



---

## Coordination tables

### Discrimination and back-up

---

time delay. Selective circuit-breakers, often of the open type, must be used for the various levels (category B circuit-breakers according to the IEC 60947-2 Standard) to guarantee a sufficiently high short-time withstand current;

- the duration of the disturbance induced by the short-circuit current on the power supply voltages in the zones unaffected by the fault can pose problems with electromechanical (voltage below the electromagnetic release value) and electronic devices;
- the number of discrimination levels is limited by the maximum time which can be withstood by the electrical system without loss of stability.

#### **Zone (or logical) selectivity**

This type of coordination is a further evolution of time coordination and can be direct or indirect. Generally speaking, it is implemented by means of a dialogue between current-measuring devices which, when they detect that the setting threshold has been exceeded, enable correct identification and power supply disconnection of just the zone affected by the fault.

It can be implemented in two ways:

- the measuring devices send information to the supervision system about the fact that the set current threshold has been exceeded and the latter decides which protection device to trip;
- when there are current values over the set threshold, each protection device sends a blocking signal via a direct connection or a bus to the protection device higher in the hierarchy (i.e. on the supply side in relation to the direction of the power flow) and, before it trips, makes sure that a similar blocking signal has not arrived from the protection device on the load side. This way, only the protection device immediately to the supply side of the fault is tripped.

The first mode has trip times of around 0.5-5 s and is mainly used in the case of not particularly high short-circuit currents with a power flow direction not unequivocally defined (e.g. for lighting systems in long road and rail tunnels).

The second mode has distinctly shorter trip times: compared with time type coordination, there is no longer any need to increase the intentional time delay progressively as you move closer to the power supply source. The delay can be reduced to a waiting time sufficient to rule out any presence of a block signal from the protection device on the load side (time taken by the device to detect the anomalous situation and successfully complete transmission of the signal).

Compared with time type coordination, zone selectivity implemented in this way:

- reduces the trip times and increases the safety level. The trip times can be around a hundred milliseconds;
- reduces both the damage caused by the fault and the disturbance to the power supply network;
- reduces the thermal and dynamic stresses on the circuit-breakers;
- allows a very high number of discrimination levels;

but it is more burdensome both in terms of costs and in the complexity of the installation.

This solution is therefore mainly used in systems with high rated current and short-circuit current values, with inescapable needs both in terms of safety and service continuity: in particular, examples of logical discrimination are often found in primary distribution switchgear, immediately to the load side of transformers and generators.

Another interesting application is the combined use of zone and time type selectivity, in which the stretches of the coordination chain managed logically have protection device trip times for short-circuits which decrease progressively moving up towards the power supply sources. The zone selectivity function is available with:

- Emax circuit-breakers equipped with PR122/P and PR123/P electronic releases
- Tmax circuit-breakers equipped with PR223EF electronic releases.

For further information, please consult the specific technical catalogues.

---

## Coordination tables

### Discrimination and back-up

---

#### Energy-based selectivity

Energy-based coordination is a particular type of selectivity which exploits the current-limiting characteristics of moulded-case circuit-breakers. It is important to remember that a current-limiting circuit-breaker is “a circuit-breaker with a trip time short enough to prevent the short-circuit current reaching the peak value it would otherwise reach”<sup>7</sup>.

In practice, all the ABB SACE moulded-case circuit-breakers in the Isomax and Tmax ranges have more or less accentuated current-limiting features, obtained by:

- reaching a valid compromise between the capacity of the release to withstand current values lower than the instantaneous trip thresholds and the repulsion of the main contacts at short-circuit currents;
- triggering rapid displacement of the arc inside the arcing chambers (magnetic blast) suitably designed to generate a high arcing voltage;
- placing several arcing chambers in series, with contacts optimised to carry out different functions (main opening under short-circuit, backup opening with the principal function of isolation and opposition to the recovery voltage, etc.).

Under short-circuit conditions, these circuit-breakers are extremely rapid (with trip times of a few milliseconds) and open in the event of a strong asymmetric component. It is therefore not possible to use the time-current trip curves (load side circuit-breaker) and no trip limit curves (supply side circuit-breaker), obtained with symmetrical sine wave forms, to study the coordination. The phenomena are mainly dynamic (and therefore proportional to the square of the instantaneous current value) and can be described using the specific let-through energy and no trip limit energy curves of the supply side circuit-breaker.

What generally happens is that the energy associated with the load side circuit-breaker trip is lower than the energy value needed to complete the opening of the supply side circuit-breaker. To ensure a good level of reliability, avoiding any oversizing or transient contact repulsion phenomena in the circuit-breaker on the supply side, this calculation should be integrated with additional information, such as the current limiting curves (peak  $I_p$  value - prospective value of the symmetrical component of the short-circuit current) and the setting for contact repulsion.

This type of selectivity is certainly more difficult to consider than the previous ones because it depends largely on the interaction between the two devices placed in series (wave forms, etc.) and requires access to data often unavailable to the end user.

Manufacturers provide tables, slide rules and calculation programs in which the limit selectivity current values  $I_s$  under short-circuit conditions between different combinations of circuit-breakers are given. These values are defined by theoretically integrating the results of a large number of tests performed in compliance with the requirements of appendix A of the IEC 60947-2 Standard.

The advantages of using this type of coordination include:

- breaking is fast, with trip times which become shorter as the short-circuit current increases. This consequently reduces the damage caused by the fault (thermal and dynamic stresses), the disturbance to the power supply system, the sizing costs, etc.;
- the discrimination level is no longer limited by the value of the short-time current  $I_{cw}$  withstood by the devices;
- a large number of hierarchically different levels can be coordinated;

---

<sup>7</sup> IEC 60947-2 Standard, def. 2.3



---

## Coordination tables

### Discrimination and back-up

---

- different current-limiting devices (fuses, circuit-breakers, etc.) can be coordinated, even when located in intermediate positions along the chain.

This type of coordination is used above all for secondary and final distribution, with rated currents below 1600 A.

#### Back-up protection

With backup protection, discrimination is sacrificed in favour of the need to help the load side devices which have to interrupt short-circuit currents beyond their breaking capacity. In this case, over and above the switching current  $I_B$ , simultaneous opening of both the protection devices placed in series or, alternatively, of just the supply side circuit-breaker (a somewhat rare case, typical of a configuration consisting of a supply side circuit-breaker and a load side isolator).

Manufacturers provide tables derived from tests based on the previously-mentioned appendix A of the IEC 60947-2 Standard.

These combinations can be calculated according to the instructions given in section A.6.2 of the above standard, comparing:

- the value of the Joule integral of the device protected at its breaking capacity with that of the supply side device at the prospective current of the association (maximum short-circuit current for which backup protection is provided);
- the effects induced in the load side device (e.g. by the arcing energy, maximum peak current and limited current) at the peak current value during operation of the protection device against a supply side short-circuit.

#### Conclusions

Technically a large number of solutions can be realised regarding coordination of the protection devices in an installation.

Selecting which type of coordination to use in the various zones of the installation is strictly linked to installation and design parameters and stems from a series of compromises so that the objectives required in terms of reliability and availability are achieved keeping the costs and limiting the risks within acceptable limits.

The designer's task is to choose a solution, for the various installation zones, from among those available which offers the best balance between technical and financial requirements according to:

- functional and safety requirements (acceptable risk levels) and reliability (availability of the installation);
- the reference value of the electrical values;
- the costs (protection devices, control systems, interconnection components, etc.);
- the effects, the admissible duration and the cost of electrical disservices;
- any future evolution of the system.

For each of the proposed solutions, there is a combination of ABB products which can meet these requirements.

---

# Coordination tables

## General notes on motor protection and switching

---

### Electromechanical starter

The starter is designed to:

- start motors;
- ensure continuous functioning of motors;
- disconnect motors from the supply line;
- guarantee protection of motors against working overloads.

The starter is typically made up of a switching device (contactor) and an overload protection device (thermal release).

The two devices must be coordinated with equipment capable of providing protection against short-circuit (typically a circuit breaker with magnetic release only), which is not necessarily part of the starter.

The characteristics of the starter must comply with the international Standard IEC 60947-4-1, which defines the above as follows:

**Contactors:** a mechanical switching device having only one position of rest, operated otherwise than by hand, capable of making, carrying and breaking currents under normal circuit conditions including operating overload conditions.

**Thermal release:** thermal overload relay or release which operates in the case of overload and also in case of loss of phase.

**Circuit-breaker:** defined by IEC 60947-2 as a mechanical switching device, capable of making, carrying and breaking currents under normal circuit conditions and also making, carrying for a specified time and breaking currents under specified abnormal circuit conditions.

The main types of motor which can be operated and which determine the characteristics of the starter are defined by the following utilization categories:

**Table 1: Utilization categories and typical applications**

Current type	Utilization categories	Typical applications
Alternating current AC	AC-2	Slip-ring motors: starting, switching off
	AC-3	Squirrel-cage motors: starting, switching off during running <sup>(1)</sup>
	AC-4	Squirrel-cage motors: starting, plugging, inching

<sup>(1)</sup> AC-3 categories may be used for occasionally inching or plugging for limited time periods such as machine set-up; during such limited time periods the number of such operations should not exceed five per minutes or more than ten in a 10 minutes period.

The choice of the starting method and also, if necessary, of the type of motor to be used depends on the typical resistant torque of the load and on the short-circuit power of the motor supplying network.

With alternating current, the most commonly used motor types are as follows:

- asynchronous three-phase squirrel-cage motors (AC-3): the most widespread type due to the fact that they are of simple construction, economical and sturdy; they develop high torque with short acceleration times, but require elevated starting currents;
- slip-ring motors (AC-2): characterized by less demanding starting conditions, and have quite a high starting torque, even with a supply network of low power.

# Coordination tables

## General notes on motor protection and switching

### Starting methods

The most common starting methods for asynchronous squirrel-cage motors are detailed below.

#### Direct starting (DOL)

With direct starting, the DOL (Direct On Line) starter, with the closing of line contactor KL, the line voltage is applied to the motor terminals in a single operation. Hence a squirrel-cage motor develops a high starting torque with a relatively reduced acceleration time. This method is generally used with small and medium power motors which reach full working speed in a short time.

These advantages are, however, accompanied by a series of drawbacks, including, for example:

- high current consumption and associated voltage drop which may cause damages to the other parts of the system connected to the network;
- violent acceleration which has negative effects on mechanical transmission components (belts, chains and mechanical joints), reducing working life.

Other types of starting for squirrel-cage motors are accomplished by reducing the supply voltage of the motor: this leads to a reduction in the starting current and of the motor torque, and an increase in the acceleration time.

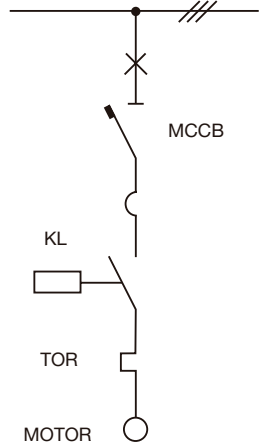

#### Star-Delta starter (Y-Δ)

The most common reduced voltage starter is the Star-Delta starter (Y-Δ), in which:

- on starting, the stator windings are star-connected, thus achieving the reduction of peak inrush current;
- once the normal speed of the motor is nearly reached, the switchover to delta is carried out.

After the switchover, the current and the torque follow the progress of the curves associated with normal service connections (delta).

As can be easily checked, starting the motor with star-connection gives a voltage reduction of  $\sqrt{3}$ , and the current absorbed from the line is reduced by 1/3 compared with that absorbed with delta-connection.

The start-up torque, proportional to the square of the voltage, is reduced by 3 times, compared with the torque that the same motor would supply when delta-connected.

This method is generally applied to motors with power from 15 to 355 kW, but intended to start with a low initial resistant torque.

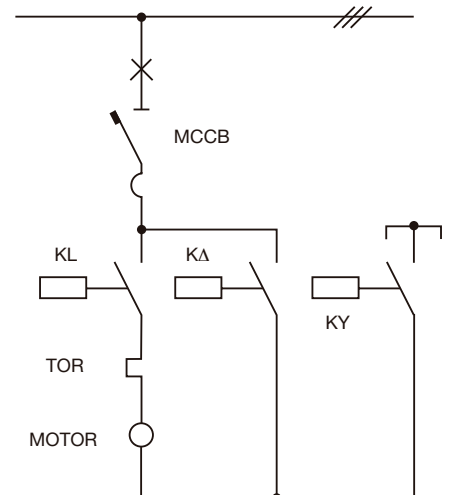

---

## Coordination tables

### General notes on motor protection and switching

---

#### Starting sequence

By pressing the start button, contactors KL and KY are closed. The timer starts to measure the start time with the motor connected in star. Once the set time has elapsed, the first contact of the timer opens the KY contactor and the second contact, delayed by approximately 50-80 ms, closes the K $\Delta$  contactor.

With this new configuration, contactors KL and K $\Delta$  closed, the motor becomes deltaconnected.

The thermal release TOR, inserted in the delta circuit, can detect any 3rd harmonic currents, which may occur due to saturation of the magnetic pack and by adding to the fundamental current, overload the motor without involving the line.

With reference to the connection diagram, the equipment used for a Star/Delta starter must be able to carry the following currents:

$$\frac{I_e}{\sqrt{3}} \quad \text{KL line contactor and K}\Delta \text{ delta contactor}$$

$$\frac{I_e}{3} \quad \text{KY star contactor}$$

$$\frac{I_e}{\sqrt{3}} \quad \text{overload protection release}$$

where  $I_e$  is the rated current of the motor.

With reference to the previously-mentioned Standard, the starter can be classified according to the tripping time (Trip Class) and to the coordination type implemented by means of a protection device against short-circuit (Type 1 and Type 2).

#### Trip classes

The trip classes differentiate between the thermal releases according to their trip curve. The trip classes are defined in the following table 2:

**Table 2: Trip class**

Trip Class	Trip time in seconds (Tp)
10 A	$2 < T_p \leq 10$
10	$4 < T_p \leq 10$
20	$6 < T_p \leq 20$
30	$9 < T_p \leq 30$

where  $T_p$  is the cold trip time of the thermal release at 7.2 times the set current value (for example: a release in class 10 at 7.2 times the set current value must not trip within 4 s, but must trip within 10 s).

It is normal procedure to associate class 10 with a normal start-up type, and class 30 with a heavy duty start-up type.

---

## Coordination tables

### General notes on motor protection and switching

---

#### **Coordination type**

##### *Type 1*

It is acceptable that in the case of short-circuit the contactor and the thermal release may be damaged. The starter may still not be able to function and must be inspected; if necessary, the contactor and/or the thermal release must be replaced, and the breaker release reset.

##### *Type 2*

In the case of short-circuit, the thermal release must not be damaged, while the welding of the contactor contacts is allowed, as they can easily be separated (with a screwdriver, for example), without any significant deformation.

---

## Coordination tables

### Switch-disconnectors

---

#### Switch-disconnectors

Switch-disconnectors are mechanical switching devices, capable of closing, carrying and interrupting currents under normal circuit conditions which can include specific overload switching conditions and which, in the open position, satisfy the isolation requirements specified for an isolator.

A switch-disconnector can be able to close and carry currents - for an established time - under specific abnormal circuit conditions, such as those which occur in the case of a short-circuit.

The Standard regarding switch-disconnectors is IEC 60947-3.

Each switch-disconnector must be protected by a coordinated device which safeguards it against overcurrents - normally a circuit-breaker, and which is able to limit the peak values of the short-circuit current and the specific let-through energy, to acceptable levels for the switch-disconnector.



---

# Coordination tables

## Back-up

---

Notes for use.....	1/3
MCB - MCB (240 V) .....	1/4
MCCB - MCB (240 V) .....	1/5
MCB - MCB (415 V) .....	1/6
MCCB - MCB (415 V) .....	1/7
MCCB - MCCB .....	1/8





# Back-up

## Notes for use

### Back-up protection

The tables given provide the value (in kA, referring to the breaking capacity according to the IEC 60947-2 Standard) for which the back-up protection among the combination of selected circuit-breakers is verified. The tables cover the possible combinations between ABB SACE Tmax and Isomax series of moulded-case circuit-breakers and those between the above-mentioned circuit-breakers and the ABB series of miniature circuit-breakers.

The values indicated in the tables refer to the voltage:

- Vn of 230/240 V AC for coordination with miniature S9 circuit-breakers
- Vn of 400/415 V AC for all the other coordinations.

### Note

The following tables give the breaking capacities at 415 V AC for circuit-breakers SACE Isomax and Tmax.

Tmax @ 415 V AC	
Version	I <sub>cu</sub> [kA]
B	16
C	25
N	36
S	50
H	70
L (T2)	85
L (T4, T5)	120
L (T6)	100
V	200

Isomax @ 415 V AC	
Version	I <sub>cu</sub> [kA]
S	50
H	65
L	100

### Caption

MCB = miniature circuit-breakers (S9, S2, S500)

MCCB = moulded-case circuit-breakers (Tmax, Isomax)

For moulded-case or air circuit-breakers:

TM = thermomagnetic release

- TMD (Tmax)

- TMA (Tmax)

M = magnetic only release

- MF (Tmax)

- MA (Tmax)

EL = electronic release

- PR211/P - PR212/P (Isomax)

- PR221DS - PR222DS (Tmax)

For miniature circuit-breakers:

B = trip characteristic (I<sub>m</sub>=3...5I<sub>n</sub>)

C = trip characteristic (I<sub>m</sub>=5...10I<sub>n</sub>)

D = trip characteristic (I<sub>m</sub>=10...20I<sub>n</sub>)

K = trip characteristic (I<sub>m</sub>=8...14I<sub>n</sub>)

Z = trip characteristic (I<sub>m</sub>=2...3I<sub>n</sub>)

### Caption of symbols



MCB

Tmax

Isomax

Emax

For solutions not shown in these tables, please consult the website:

<http://bol.it.abb.com>

or contact ABB SACE

## Back-up

Supply side circuit-breaker: MCB

Load side circuit-breaker: MCB

### MCB - MCB @ 240 V (Two-pole circuit-breakers)

Load s.	Char.	Supply s.		S 200L	S200	S200M	S200P		S 280	S 290	S 500
		$I_{cu}$ [kA]	$I_n$ [A]	C	B-C	B-C	B-C	B-C	B-C	C	B-C
				10	20	25	40	25	20	25	100
S931 N	C	4,5	2..40	6..40	0.5..63	0.5..63	0.5..25	32..63	80, 100	80..125	6..63
S941 N	B,C	6	2..40	10	20	25	40	25	15	15	100
S951 N	B,C	10	2..40	10	20	25	40	25	15	15	100
S971 N	B,C	10	2..40	10	20	25	40	25	15	15	100
S200L	C	10	6..40		20	25	40	25	15	15	100
S200	B,C,K,Z	20	0.5..63			25	40	25			100
S200M	B,C,D	25	0.5..63				40				100
S200P	B, C,	40	0.5..25								100
	D, K, Z	25	32..63								100
S280	B,C	20	80, 100								
S290	C,D	25	80..125								
S500	B,C,D	100	6..63								



## Back-up

Supply side circuit-breaker: MCCB

Load side circuit-breaker: MCB

### MCCB @ 415 V - MCB @ 240 V

Load s.	Char.	I <sub>n</sub> [A]	I <sub>cu</sub> [kA]	Supply s.*			T2		T3		T2	
				Version	B	C	N	S	H	L		
				16	25	36			50		70	85
S931 N	C	2..25	4,5	16	16	16	20	10	20	10	20	20
		32, 40		10	10	10	16		16		16	16
S941 N	B,C	2..25	6	16	16	16	20	10	20	10	20	20
		32, 40		10	10	10	16		16		16	16
S951 N	B,C	2..25	10	16	16	16	25	16	25	16	25	25
		32, 40		16	16	16	16		16		16	16
S971 N	B,C	2..25	10	16	16	16	25	16	25	16	25	25
		32, 40		16	16	16	16		16		16	16

\* Supply side circuit-breaker 4P (load side circuit branched between one phase and the neutral)

1



# Back-up

Supply side circuit-breaker: MCB

Load side circuit-breaker: MCB

## MCB - MCB @ 415 V

Load s.	Char.	Supply s.		S 200L	S200	S200M	S200P		S 280	S 290	S 500
		$I_{cu}$ [kA]	$I_n$ [A]	C	B-C	B-C	B-C	B-C	B-C	C	B-C
				6	10	15	25	15	6	15	50
S200L	C	6	6..40	6..40	10	15	25	32..63	80, 100	80..125	6..63
S200	B,C,K,Z	10	0.5..63			15	25	15		15	50
S200M	B,C,D	15	0.5..63				25				50
S200P	B, C,	25	0.5..25								50
	D, K, Z	15	32..63								
S280	B,C	6	80, 100								
S290	C,D	15	80..125								
S500	B,C,D	50	6..63								





# Back-up

Supply side circuit-breaker: MCCB

Load side circuit-breaker: MCB

## MCCB - MCB @ 415 V

Load s.	Char.	I <sub>n</sub> [A]	Supply s.	T1	T1	T1	T2	T3	T4	T2	T3	T4	T2	T4	T2	T4	T4
			Version	B	C	N			S			H		L	L	V	
			I <sub>cu</sub> [kA]	16	25	36			50			70		85	120	200	
S200L	C	6..10	6	16	25	30	36	36	36	36	40	40	40	40	40	40	40
		13..40						16			16						
S200	B,C,K,Z	0.5..10	10	16	25	30	36	36	36	36	40	40	40	40	40	40	40
		13..63						16			16						
S200M	B,C,D	0.5..10	15	16	25	30	36	36	36	50	40	40	70	40	85	40	40
		13..63						25			25		60		60		
S200P	B, C, D, K, Z	0.5..10	25			30	36	36	36	50	40	40	70	40	85	40	40
		13..25				30	36	30	36	50	30	40	60	40	60	40	40
		32..63		15	16	25	30	36	25	36	50	25	40	60	40	60	40
S280	B,C	80, 100	6	16	16	16	36	16	30	36	16	30	36	30	36	30	30
S290	C,D	80..125	15	16	25	30	36	30	30	50	30	30	70	30	85	30	30
S500	B,C,D	6..63	50										70	70	85	120	200

1



# Back-up

Supply side circuit-breaker: MCCB

Load side circuit-breaker: MCCB

## MCCB - MCCB @ 415 V

Load s.	Char.	Supply s. Version	T1	T1	T2	T3	T4	T5	T6	T2	T3	T4	T5	T6	S7	T2	T4	T5	T6	S7	T2	T4	T5	T6	S7	T4	T5	
			C	N						S					H				L	L	L	V						
		$I_{cu}$ [kA]	25	36						50					70				65	85	120	100	200					
T1	B	16	25	36	36	36	30	30	30	50	50	36	36	36		70	40	40	40		85	50	50	50		85	65	
T1	C	25		36	36	36	36	36	36	50	50	40	40	50	50	70	65	65	65	50	85	85	85	70	50	130	100	
T1	N	36								50	50	50	50	50	50	70	65	65	65	50	85	100	100	70	50	200	120	
T2											50	50	50	50	50	50	70	65	65	65	65	85	100	100	85	85	200	120
T3												50	50	50	50	50		65	65	65	50		100	100	100	50	200	120
T4													50	50	50	50		65	65	65	50		100	100	65	65	200	120
T5														50	50	50			65	65	50			100	85	65		120
T6															50	40				65	40				70	50		
T2	S	50														70	70	70	65	85	100	100	85	85	200	130		
T3																	70	70	70			100	100	100		200	150	
T4																	70	70	70	65		100	100	85	85	200	150	
T5																			70	70	65			100	85	85		150
T6																				70					85	85		
T2	H	70																			85	120	120	85	85	200	150	
T4																							120	120	100	100	200	180
T5																								120	100	100		180
T6																									100	85		
T2	L	85																				120	120			200	180	
T4		120																								200	200	
T5																											200	



---

## Coordination tables

### Discrimination

---

Notes for use .....	2/2
MCB - MCB (240 V) .....	2/4
MCCB - MCB (240 V) .....	2/6
MCB - MCB (415 V)	
MCB - S200L .....	2/8
MCB - S200 .....	2/9
MCB - S200M .....	2/11
MCB - S200P .....	2/12
MCB - S500 .....	2/14
MCCB - MCB	
T1 - MCB .....	2/15
T2 - MCB .....	2/22
T3 - MCB .....	2/29
T4 - MCB .....	2/36
MCCB - MCCB	
MCCB - T1 .....	2/44
MCCB - T2 .....	2/46
MCCB - T3 .....	2/54
MCCB - T4 .....	2/54
MCCB - T5 .....	2/56
MCCB - T6 .....	2/56
ACB - MCCB .....	2/57

---

# Discrimination

## Notes for use

---

### Selective protection

The tables given provide the value (in kA, referring to the breaking capacity according to the IEC 60947-2 Standard) for which the selective protection is verified among the combination of selected circuit-breakers. The tables cover the possible combinations between ABB SACE Emax series air circuit-breakers, ABB SACE Tmax and Isomax series of moulded-case circuit-breakers, and the ABB series of miniature circuit-breakers.

The values in the table represent the maximum value obtainable of discrimination between supply side circuit-breaker and load side circuit-breaker referring to the voltage:

- Vn of 230/240 V AC for the S9 circuit-breakers and Vn of 400/415 V AC for the supply side circuit-breakers in the coordination between MCB with the miniature S9 circuit-breakers.
- Vn of 400/415 V AC for all the other coordinations.

These values are obtained following particular specifications which, when not respected, could give discrimination values which are in some cases much lower than what is indicated. Some of these are generally valid and are given below, others referring exclusively to particular types of circuit-breakers will be the subject of a note under the relative table.

### General prescriptions

- Function I of the electronic releases of the supply side circuit-breakers must be excluded ( $I_3$  in OFF);
- The magnetic trip of thermomagnetic (TM) or magnetic only (M) circuit-breakers placed on the supply side must be  $\geq 10 \times I_n$  and regulated to the maximum threshold;
- It is of prime importance to check that the settings made by the user for the electronic and thermomagnetic relays of circuit-breakers placed both on the load and supply side results in time-current curves properly spaced.

# Discrimination

## Notes for use

### Note

The letter **T** indicates total discrimination for the selected combination; the corresponding value in kA is obtained by considering the lowest between the breaking capacities ( $I_{cu}$ ) of the circuit-breaker on the load side and the circuit-breaker on the supply side.

The following tables give the breaking capacities at 415 V AC for SACE Emax, Isomax and Tmax circuit-breakers.

Tmax @ 415 V AC	
Version	$I_{cu}$ [kA]
B	16
C	25
N	36
S	50
H	70
L (T2)	85
L (T4, T5)	120
L (T6)	100
V	200

Isomax @ 415 V AC	
Version	$I_{cu}$ [kA]
S	50
H	65
L	100

Emax @ 415 V AC	
Version	$I_{cu}$ [kA]
B	42
N (E1)	50
N	65
S	75
S (E2)	85
H	100
L	130
V (E3)	130
V	150

2

### Caption

MCB = miniature circuit-breakers (S9, S2, S500)

MCCB = moulded-case circuit-breakers (Tmax, Isomax)

ACB = air circuit-breakers (Emax)

For moulded-case or air circuit-breakers:

TM = thermomagnetic release

– TMD (Tmax)

– TMA (Tmax)

M = magnetic only release

– MF (Tmax)

– MA (Tmax)

EL = electronic release

– PR121/P - PR122/P - PR123/P (Emax)

– PR211/P - PR212/P (Isomax)

– PR221DS - PR222DS (Tmax)

For miniature circuit-breakers:

B = trip characteristic ( $I_m=3...5I_n$ )

C = trip characteristic ( $I_m=5...10I_n$ )

D = trip characteristic ( $I_m=10...20I_n$ )

K = trip characteristic ( $I_m=8...14I_n$ )

Z = trip characteristic ( $I_m=2...3I_n$ )

### Caption of symbols



MCB Tmax Isomax Emax

For solutions not shown in these tables, please consult the website:

<http://bol.it.abb.com>

or contact ABB SACE

## Discrimination

Supply side circuit-breaker: MCB

Load side circuit-breaker: MCB

### MCB - S9 @ 230/240 V

Load s.*	Char.	Supply s.**	I <sub>cu</sub> [kA]	S290					S500						
				C			D		B						
				15					50						
I <sub>n</sub> [A]	80	100	125	80	100	16	20	25	32	40	50	63			
S931N	B-C	4.5	2	T	T	T	T	T	0.1	0.15	0.2	0.3	0.4	0.5	0.6
			4	T	T	T	T	T		0.06	0.15	0.25	0.3	0.4	0.5
			6	T	T	T	T	T			0.075	0.2	0.25	0.3	0.4
			10	4	T	T	T	T				0.15	0.2	0.25	0.3
			16	2.5	3.5	3.5	4	T							0.3
			20	1.5	2.5	2.5	3	T							0.3
			25	0.5	0.5	1.5	2	4							0.3
			32	0.5	0.5	0.5	1.5	3.5							
S941N	B-C	6	2	T	T	T	T	T	0.1	0.15	0.2	0.3	0.4	0.5	0.6
			4	5	T	T	T	T			0.15	0.25	0.3	0.4	0.5
			6	4.5	5	T	5.5	T				0.2	0.25	0.3	0.4
			10	4	4.5	5	5	5				0.15	0.2	0.25	0.3
			16	2.5	3.5	3.5	4	4.5							0.3
			20	1.5	2.5	2.5	3	4.5							0.3
			25	0.5	0.5	1.5	2	4							0.3
			32	0.5	0.5	0.5	1.5	3.5							
S951N	B-C	10	2	6	8	9	7	8	0.1	0.15	0.2	0.3	0.4	0.5	0.6
			4	5	6	7.5	6	7			0.15	0.25	0.3	0.4	0.5
			6	4.5	5	6	5.5	6				0.2	0.25	0.3	0.4
			10	4	4.5	5	5	5				0.15	0.2	0.25	0.3
			16	2.5	3.5	3.5	4	4.5							0.3
			20	1.5	2.5	2.5	3	4.5							0.3
			25	0.5	0.5	1.5	2	4							0.3
			32	0.5	0.5	0.5	1.5	3.5							
S971N	B-C	10	2	6	8	9	7	8	0.1	0.15	0.2	0.3	0.4	0.5	0.6
			4	5	6	7.5	6	7			0.15	0.25	0.3	0.4	0.5
			6	4.5	5	6	5.5	6				0.2	0.25	0.3	0.4
			10	4	4.5	5	5	5				0.15	0.2	0.25	0.3
			16	2.5	3.5	3.5	4	4.5							0.3
			20	1.5	2.5	2.5	3	4.5							0.3
			25	0.5	0.5	1.5	2	4							0.3
			32	0.5	0.5	0.5	1.5	3.5							

\* Load side circuit-breaker 1P+N (230/240 V)

\*\* For networks with 230/240 V AC ⇒ two-pole circuit-breaker (phase + neutral)

for networks at 400/415 V AC ⇒ four-pole circuit-breaker (load side circuit branched between one phase and the neutral)







S500										S500								
C										D								
50										50								
10	13	16	20	25	32	40	50	63	10	13	16	20	25	32	40	50	63	
0.1	0.2	0.34	0.53	0.58	0.62	0.7	0.85	1	0.24	0.5	1	2	3	T	T	T	T	
	0.15	0.26	0.4	0.53	0.58	0.62	0.7	0.85	0.2	0.32	0.5	1	2	3.5	T	T	T	
	0.1	0.2	0.26	0.4	0.53	0.58	0.62	0.7	0.15	0.24	0.35	0.5	1	2	4	T	T	
		0.15	0.2	0.34	0.48	0.53	0.58	0.62		0.2	0.32	0.35	0.5	0.5	2	T	T	
			0.15	0.26	0.4	0.48	0.53	0.58			0.24	0.3	0.5	0.5	1.5	3.5	T	
				0.2	0.34	0.4	0.48	0.53					0.35	0.5	1	2.5	3.5	
					0.26	0.34	0.4	0.48						0.5	0.5	1.5	2	
					0.26	0.34	0.4	0.48							0.5	1	1.5	
					0.26	0.34	0.4	0.48								0.5	1	
0.1	0.2	0.34	0.53	0.58	0.62	0.7	0.85	1	0.24	0.5	1	2	3	5	T	T	T	
	0.15	0.26	0.4	0.53	0.58	0.62	0.7	0.85	0.2	0.32	0.5	1	2	3.5	5	T	T	
	0.1	0.2	0.26	0.4	0.53	0.58	0.62	0.7	0.15	0.24	0.35	0.5	1	2	4	5.5	T	
		0.15	0.2	0.34	0.48	0.53	0.58	0.62		0.2	0.32	0.35	0.5	0.5	2	4.5	T	
			0.15	0.26	0.4	0.48	0.53	0.58			0.24	0.3	0.5	0.5	1.5	3.5	5.5	
				0.2	0.34	0.4	0.48	0.53					0.35	0.5	1	2.5	3.5	
					0.26	0.34	0.4	0.48						0.5	0.5	1.5	2	
					0.26	0.34	0.4	0.48							0.5	1	1.5	
					0.26	0.34	0.4	0.48								0.5	1	
0.1	0.2	0.34	0.53	0.58	0.62	0.7	0.85	1	0.24	0.5	1	2	3	5	6	7	9	
	0.15	0.26	0.4	0.53	0.58	0.62	0.7	0.85	0.2	0.32	0.5	1	2	3.5	5	6	8	
	0.1	0.2	0.26	0.4	0.53	0.58	0.62	0.7	0.15	0.24	0.35	0.5	1	2	4	5.5	7	
		0.15	0.2	0.34	0.48	0.53	0.58	0.62		0.2	0.32	0.35	0.5	0.5	2	4.5	6	
			0.15	0.26	0.4	0.48	0.53	0.58			0.24	0.3	0.5	0.5	1.5	3.5	5.5	
				0.2	0.34	0.4	0.48	0.53					0.35	0.5	1	2.5	3.5	
					0.26	0.34	0.4	0.48						0.5	0.5	1.5	2	
					0.26	0.34	0.4	0.48							0.5	1	1.5	
					0.26	0.34	0.4	0.48								0.5	1	

2

# Discrimination

Supply side circuit-breaker: MCCB

Load side circuit-breaker: MCB

**MCCB @ 415 V 4p - S9 @ 240 V**

Load s.	Char.	I <sub>cu</sub> [kA]	Supply s. Version Release I <sub>n</sub> [A]	T1												TMD, MA					
				B, C, N																	
				TMD																	
160																					
				16	20	25	32	40	50	63	80	100	125	160**	160	16	20	25	32	40	50
S931N	C	4.5	≤4	T	T	T	T	T	T	T	T	T	T	T	T	T	T	T	T	T	
	C		6	T	T	T	T	T	T	T	T	T	T	T	T	T	T	T	T	T	
	C		10			3	3	3	T	T	T	T	T	T	T		3*	3	3	3	T
	C		16					3	T	T	T	T	T	T				3*	3	T	
	C		20						3	T	T	T	T	T				3*		3	
	C		25							T	T	T	T	T						3*	
	C		32								T	T	T	T						3*	
	C		40									T	T	T							
S941N	B-C	6	≤4	T	T	T	T	T	T	T	T	T	T	T	T	T	T	T	T	T	
	B-C		6	T	T	T	T	T	T	T	T	T	T	T	T	T	T	T	T	T	
	B-C		10			3	3	3	4.5	T	T	T	T	T		3*	3	3	3	4.5	
	B-C		16					3	4.5	5	T	T	T	T				3*	3	4.5	
	B-C		20						3	5	T	T	T	T				3*		3	
	B-C		25							5	T	T	T	T						3*	
	B-C		32								T	T	T	T						3*	
	B-C		40									T	T	T							
S951N	B-C	10	≤4	T	T	T	T	T	T	T	T	T	T	T	T	T	T	T	T	T	
	B-C		6	6	6	6	6	6	6	T	T	T	T	T	T	T	T	T	T	T	
	B-C		10			3	3	3	4.5	7.5	8.5	T	T	T	T		3*	3	3	4.5	
	B-C		16					3	4.5	5	7.5	T	T	T	T				3*	3	4.5
	B-C		20						3	5	6	T	T	T	T				3*		3
	B-C		25							5	6	T	T	T	T						3*
	B-C		32								6	7.5	T	T	T						3*
	B-C		40									7.5	T	T	T						
S971N	B-C	10	≤4	T	T	T	T	T	T	T	T	T	T	T	T	T	T	T	T	T	
	B-C		6	6	6	6	6	6	6	12	T	T	T	T	T	T	T	T	T	T	
	B-C		10			3	3	3	4.5	7.5	8.5	T	T	T	T		3*	3	3	4.5	
	B-C		16					3	4.5	5	7.5	T	T	T	T				3*	3	4.5
	B-C		20						3	5	6	T	T	T	T				3*		3
	B-C		25							5	6	T	T	T	T						3*
	B-C		32								6	7.5	T	T	T						3*
	B-C		40									7.5	T	T	T						

Supply side circuit-breaker 4P (load side circuit branched between one phase and the neutral)

Load side circuit-breaker 1P+N (230/240 V)

\* Value valid only for magnetic only supply side circuit-breaker

\*\* Neutral 50%





T2												T3											
N, S, H, L												N, S											
								EL				TMD, MA											
160												250											
63	80	100	125**	125	160**	160	10	25	63	100	160	63	80	100	125**	125	160**	160	200**	200	250**	250	
T	T	T	T	T	T	T	T	T	T	T	T	T	T	T	T	T	T	T	T	T	T	T	
T	T	T	T	T	T	T		T	T	T	T	T	T	T	T	T	T	T	T	T	T	T	
T	T	T	T	T	T	T		T	T	T	T	T	T	T	T	T	T	T	T	T	T	T	
T	T	T	T	T	T	T			T	T	T	T	T	T	T	T	T	T	T	T	T	T	
T	T	T	T	T	T	T			T	T	T	T	T	T	T	T	T	T	T	T	T	T	
	T	T	T	T	T	T				T	T		T	T	T	T	T	T	T	T	T	T	
	T*	T		T	T	T				T	T		T*	T		T	T	T	T	T	T	T	
T	T	T	T	T	T	T	T	T	T	T	T	T	T	T	T	T	T	T	T	T	T	T	
T	T	T	T	T	T	T		T	T	T	T	T	T	T	T	T	T	T	T	T	T	T	
T	T	T	T	T	T	T		T	T	T	T	T	T	T	T	T	T	T	T	T	T	T	
5	T	T	T	T	T	T			T	T	T	5	T	T	T	T	T	T	T	T	T	T	
5	T	T	T	T	T	T				T	T	5	T	T	T	T	T	T	T	T	T	T	
5	T	T	T	T	T	T				T	T	5	T	T	T	T	T	T	T	T	T	T	
	T	T	T	T	T	T				T	T		T	T	T	T	T	T	T	T	T	T	
	T*	T		T	T	T				T	T		T*	T		T	T	T	T	T	T	T	
T	T	T	T	T	T	T	T	T	T	T	T	T	T	T	T	T	T	T	T	T	T	T	
T	T	T	T	T	T	T		T	T	T	T	T	T	T	T	T	T	T	T	T	T	T	
7.5	8.5	T	T	T	T	T		T	T	T	T	7.5	8.5	T	T	T	T	T	T	T	T	T	
5	7.5	T	7.5	T	T	T			T	T	T	5	7.5	T	7.5	T	T	T	T	T	T	T	
5	6	T	6	T	T	T			T	T	T	5	6	T	6	T	T	T	T	T	T	T	
5	6	T	6	T	T	T			T	T	T	5	6	T	6	T	T	T	T	T	T	T	
	6	7.5	6	T	T	T			T	T	T		6	7.5	6	T	T	T	T	T	T	T	
	6*	7.5		T	T	T				T	T		6*	7.5		T	T	T	T	T	T	T	
T	T	T	T	T	T	T	T	T	T	T	T	T	T	T	T	T	T	T	T	T	T	T	
T	T	T	T	T	T	T		T	T	T	T	T	T	T	T	T	T	T	T	T	T	T	
7.5	8.5	T	T	T	T	T		T	T	T	T	7.5	8.5	T	T	T	T	T	T	T	T	T	
5	7.5	T	7.5	T	T	T			T	T	T	5	7.5	T	7.5	T	T	T	T	T	T	T	
5	6	T	6	T	T	T			T	T	T	5	6	T	6	T	T	T	T	T	T	T	
5	6	T	6	T	T	T			T	T	T	5	6	T	6	T	T	T	T	T	T	T	
	6	7.5	6	T	T	T			T	T	T		6	7.5	6	T	T	T	T	T	T	T	
	6*	7.5		T	T	T				T	T		6*	7.5		T	T	T	T	T	T	T	

2

## Discrimination

Supply side circuit-breaker: MCB

Load side circuit-breaker: MCB

### MCB - S200L @ 400/415 V

Load s.	Char.	Supply s.	S290		S500				
			D		D				
			15		50				
		$I_{cu}$ [kA]	$I_n$ [A]	80	100	32	40	50	63
S200L	C	6	6..8	T	T	1.5	2	3	5.5
			10	5	T	1	1.5	2	3
			13	4.5	T		1.5	2	3
			16	4.5	T			2	3
			20	3.5	5				2.5
			25	3.5	5				
			32		4.5				
			40						

2



## Discrimination

Supply side circuit-breaker: MCB

Load side circuit-breaker: MCB

MCB - S200 @ 400/415 V

Load s.	Char.	I <sub>cu</sub> [kA]	Supply s.	S290		S500			
			I <sub>n</sub> [A]	D		D			
				15		50			
			80	100	32	40	50	63	
S200	C	10	≤2	T	T	T	T	T	T
			3	T	T	3	6	T	T
			4	T	T	2	3	6	T
	6		T	T	1.5	2	3	5.5	
	8		T	T	1.5	2	3	5.5	
	10		5	8	1	1.5	2	3	
	13		4.5	7		1.5	2	3	
	16		4.5	7			2	3	
	20		3.5	5				2.5	
	25		3.5	5					
	32			4.5					
	40								
	50								
	63								
	D	10	≤2	T	T	T	T	T	T
			3	T	T	3	6	T	T
			4	T	T	2	3	6	T
			6	T	T	1.5	2	3	5.5
			8	T	T	1.5	2	3	5.5
			10	5	8	1	1.5	2	3
			13	3	5			1.5	2
			16	3	5			1.5	2
			20	3	5				2
			25		4				
			32						
			40						
			50						
			63						

2



## Discrimination

Supply side circuit-breaker: MCB

Load side circuit-breaker: MCB

MCB - S200 @ 400/415 V

Load s.	Char.	Supply s.	$I_{cu}$ [kA]	S290		S500			
				D		D			
				15		50			
$I_n$ [A]	80	100	32	40	50	63			
S200	K	10	≤2	T	T	T	T	T	T
			3	T	T	3	6	T	T
			4	T	T	2	3	6	T
			6	T	T	1.5	2	3	5.5
			8	T	T	1.5	2	3	5.5
			10	5	8		1.5	2	3
			16	3	5				2
			20	3	5				
			25		4				
			32						
	40								
	50								
	63								
	Z	10	≤2	T	T	T	T	T	T
			3	T	T	3	6	T	T
			4	T	T	2	3	6	T
			6	T	T	1.5	2	3	5.5
			8	T	T	1.5	2	3	5.5
			10	5	8	1	1.5	2	3
			16	4.5	7	1	1.5	2	3
20			3.5	5		1.5	2	2.5	
25			3.5	5			2	2.5	
32			3	4.5				2	
40	3	4.5							
50		3							
63									





## Discrimination

Supply side circuit-breaker: MCB

Load side circuit-breaker: MCB

MCB - S200M @ 400/415 V

Load s.	Char.	I <sub>cu</sub> [kA]	Supply s.	S290		S500			
			I <sub>n</sub> [A]	D		D			
				15	50	32	40	50	63
S200M	C	15	≤2	T	T	T	T	T	T
			3	T	T	3	6	T	T
			4	T	T	2	3	6	T
	B-C	15	6	10.5	T	1.5	2	3	5.5
			8	10.5	T	1.5	2	3	5.5
			10	5	8	1	1.5	2	3
			13	4.5	7		1.5	2	3
			16	4.5	7			2	3
			20	3.5	5				2.5
			25	3.5	5				
			32		4.5				
			40						
			50						
			63						
	D	15	≤2	T	T	T	T	T	T
			3	T	T	3	6	T	T
			4	T	T	2	3	6	T
			6	10.5	T	1.5	2	3	5.5
			8	10.5	T	1.5	2	3	5.5
			10	5	8	1	1.5	2	3
			16	3	5			1.5	2
			20	3	5				2
			25		4				
			32						
			40						
	K	15	≤2	T	T	T	T	T	T
			3	T	T	3	6	T	T
			4	T	T	2	3	6	T
			6	10.5	T	1.5	2	3	5.5
			8	10.5	T	1.5	2	3	5.5
			10	5	8		1.5	2	3
			16	3	5				2
			20	3	5				
			25		4				
			32						
			40						
50									
63									

2



## Discrimination

Supply side circuit-breaker: MCB

Load side circuit-breaker: MCB

MCB - S200P @ 400/415 V

Load s.	Char.	Supply s.	$I_{cu}$ [kA]	S290		S500				
				D		D				
				15		50				
			$I_n$ [A]	80	100	32	40	50	63	
S200P	C	25	≤2	T	T	T	T	T	T	T
			3	T	T	3	6	15	15	
			4	T	T	2	3	6	15	
	6		10.5	T	1.5	2	3	5.5		
	8		10.5	T	1.5	2	3	5.5		
	10		5	8	1	1.5	2	3		
	13		4.5	7		1.5	2	3		
	16		4.5	7			2	3		
	20		3.5	5				2.5		
	25		3.5	5						
	B-C		15	32		4.5				
				40						
		50								
		63								
	D	25	≤2	T	T	T	T	T	T	
			3	T	T	3	6	15	15	
			4	T	T	2	3	6	15	
			6	10.5	T	1.5	2	3	5.5	
			8	10.5	T	1.5	2	3	5.5	
			10	5	8	1	1.5	2	3	
			13	3	5			1.5	2	
			16	3	5			1.5	2	
			20	3	5				2	
			25		4					
			15	32						
				40						
		50								
63										



## Discrimination

Supply side circuit-breaker: MCB

Load side circuit-breaker: MCB

### MCB - S200P @ 400/415 V

Load s.	Char.	I <sub>cu</sub> [kA]	Supply s.	S290		S500			
			I <sub>n</sub> [A]	D		D			
				15		50			
			80	100	32	40	50	63	
S200P	K	25	≤2	T	T	T	T	T	T
			3	T	T	3	6	15	15
			4	T	T	2	3	6	15
			6	10.5	T	1.5	2	3	5.5
			8	10.5	T	1.5	2	3	5.5
			10	5	8		1.5	2	3
			13	3	5			1.5	2
			16	3	5				2
			20	3	5				
		25		4					
		15	32						
			40						
			50						
			63						
	Z	25	≤2	T	T	T	T	T	T
			3	T	T	3	6	15	15
			4	T	T	2	3	6	15
			6	10.5	T	1.5	2	3	5.5
			8	10.5	T	1.5	2	3	5.5
			10	5	8	1	1.5	2	3
			16	4.5	7	1	1.5	2	3
			20	3.5	5		1.5	2	2.5
			25	3.5	5			2	2.5
15		32	3	4.5				2	
	40	3	4.5						
	50		3						
	63								

2



## Discrimination

Supply side circuit-breaker: MCB

Load side circuit-breaker: MCB

MCB - S500 @ 400/415 V

Load s.	Char.	$I_{cu}$ [kA]	Supply s.	S290	
			$I_n$ [A]	D	
				80	15
S500	B-C-D	50	6	6	10
			10	6	10
			13	6	10
			16	6	10
			20	6	7.5
			25	4.5	6
			32		6
			40		
			50		
			63		
	K	50	$\leq 5.8$	T	T
			5.3..8	10	T
			7.3..11	7.5	T
		30	10..15	4.5	10
			14..20	4.5	6
			18..26		4.5
			23..32		
			29..37		
			34..41		
			38..45		



## Discrimination

Supply side circuit-breaker: MCCB

Load side circuit-breaker: MCB

**Tmax T1 - S200L @ 400/415 V**

Load s.	Char.	I <sub>cu</sub> [kA]	Supply s.	T1											
			Version	B, C, N											
			Release	TM											
			I <sub>n</sub> [A]	160											
			I <sub>n</sub> [A]	16	20	25	32	40	50	63	80	100	125	160	
S200L	C	6	6	5.5	5.5	5.5	5.5	5.5	5.5	5.5	T	T	T	T	T
			8		5.5	5.5	5.5	5.5	5.5	5.5	T	T	T	T	T
			10			3	3	3	4.5	4.5	T	T	T	T	T
			13				3	3	4.5	4.5	T	T	T	T	T
			16					3	4.5	5	T	T	T	T	T
			20						3	5	T	T	T	T	T
			25							5	T	T	T	T	T
			32								T	T	T	T	T
			40									T	T	T	T

2



## Discrimination

Supply side circuit-breaker: MCCB

Load side circuit-breaker: MCB

Tmax T1 - S200 @ 400/415 V

Load s.	Char.	I <sub>cu</sub> [kA]	Supply s.	T1											
			Version	B, C, N											
			Release	TM											
			I <sub>n</sub> [A]	160											
			I <sub>n</sub> [A]	16	20	25	32	40	50	63	80	100	125	160	
S200	C	10	≤2	T	T	T	T	T	T	T	T	T	T	T	
			3	T	T	T	T	T	T	T	T	T	T	T	
			4	T	T	T	T	T	T	T	T	T	T	T	
			6	5.5	5.5	5.5	5.5	5.5	5.5	T	T	T	T	T	
			8		5.5	5.5	5.5	5.5	5.5	T	T	T	T	T	
			10			3	3	3	4.5	7.5	8.5	T	T	T	
	B-C		13				3	3	4.5	7.5	7.5	T	T	T	
			16					3	4.5	5	7.5	T	T	T	
			20						3	5	6	T	T	T	
			25							5	6	T	T	T	
			32								6	7.5	T	T	
			40									7.5	T	T	
		50										7.5	T		
		63												T	
		D	≤2	T	T	T	T	T	T	T	T	T	T	T	T
			3	T	T	T	T	T	T	T	T	T	T	T	T
			4	T	T	T	T	T	T	T	T	T	T	T	T
			6	5.5	5.5	5.5	5.5	5.5	5.5	T	T	T	T	T	T
	8			5.5	5.5	5.5	5.5	5.5	T	T	T	T	T	T	
	10				3	3	3	3	5	8.5	T	T	T	T	
	13						2	2	3	5	8	T	T	T	
	16						2	2	3	5	8	T	T	T	
	20							2	3	4.5	6.5	T	T	T	
	25									2.5	4	6	9.5	T	
	32										4	6	9.5	T	
	40											5	8	T	
	50											5	9.5		
	63													9.5	



## Discrimination

Supply side circuit-breaker: MCCB

Load side circuit-breaker: MCB

Tmax T1 - S200 @ 400/415 V

Load s.	Char.	I <sub>cu</sub> [kA]	Supply s.	T1											
			Version	B, C, N											
			Release	TM											
			I <sub>n</sub> [A]	160											
			I <sub>n</sub> [A]	16	20	25	32	40	50	63	80	100	125	160	
S200	K	10	≤2	T	T	T	T	T	T	T	T	T	T	T	T
			3	T	T	T	T	T	T	T	T	T	T	T	T
			4	T	T	T	T	T	T	T	T	T	T	T	T
			6	5.5	5.5	5.5	5.5	5.5	5.5	5.5	T	T	T	T	T
			8		5.5	5.5	5.5	5.5	5.5	5.5	T	T	T	T	T
			10			3	3	3	3	3	6	8.5	T	T	T
			16					3	3	4.5	7.5	T	T	T	
			20						3	3.5	5.5	6.5	T	T	
			25							3.5	5.5	6	9.5	T	
			32								4.5	6	9.5	T	
			40									5	8	T	
			50										6	9.5	
			63											9.5	
			Z	10	≤2	T	T	T	T	T	T	T	T	T	T
	3	T			T	T	T	T	T	T	T	T	T	T	
	4	T			T	T	T	T	T	T	T	T	T	T	
	6	5.5			5.5	5.5	5.5	5.5	5.5	T	T	T	T	T	
	8				5.5	5.5	5.5	5.5	5.5	T	T	T	T	T	
	10					3	3	3	4.5	8	8.5	T	T	T	
	16							3	4.5	5	7.5	T	T	T	
	20								3	5	6	T	T	T	
	25									5	6	T	T	T	
	32										6	7.5	T	T	
	40											7.5	T	T	
	50												7.5	T	
	63											T			

2



# Discrimination

Supply side circuit-breaker: MCCB

Load side circuit-breaker: MCB

Tmax T1 - S200M @ 400/415 V

Load s.	Char.	I <sub>cu</sub> [kA]	Supply s.	T1										
			Version	B, C, N										
			Release	TM										
			I <sub>n</sub> [A]	160										
			I <sub>n</sub> [A]	16	20	25	32	40	50	63	80	100	125	160
S200M	C	15	≤2	T	T	T	T	T	T	T	T	T	T	T
			3	T	T	T	T	T	T	T	T	T	T	T
			4	T	T	T	T	T	T	T	T	T	T	T
			6	5.5	5.5	5.5	5.5	5.5	5.5	10.5	T	T	T	T
			8		5.5	5.5	5.5	5.5	5.5	10.5	T	T	T	T
			10			3	3	3	4.5	7.5	8.5	T	T	T
			13				3	3	4.5	7.5	7.5	12	T	T
			16					3	4.5	5	7.5	12	T	T
			20						3	5	6	10	T	T
			25							5	6	10	T	T
			32								6	7.5	12	T
			40									7.5	12	T
			50										7.5	10.5
	63											10.5		
	B-C	15	≤2	T	T	T	T	T	T	T	T	T	T	T
			3	T	T	T	T	T	T	T	T	T	T	T
			4	T	T	T	T	T	T	T	T	T	T	T
			6	5.5	5.5	5.5	5.5	5.5	5.5	10.5	T	T	T	T
			8		5.5	5.5	5.5	5.5	5.5	10.5	12	T	T	T
			10			3	3	3	3	5	8.5	T	T	T
			16					2	2	3	5	8	13.5	T
			20						2	3	4.5	6.5	11	T
			25							2.5	4	6	9.5	T
			32								4	6	9.5	T
			40									5	8	T
			50										5	9.5
			63											9.5
	D	15	≤2	T	T	T	T	T	T	T	T	T	T	T
			3	T	T	T	T	T	T	T	T	T	T	T
			4	T	T	T	T	T	T	T	T	T	T	T
			6	5.5	5.5	5.5	5.5	5.5	5.5	10.5	T	T	T	T
			8		5.5	5.5	5.5	5.5	5.5	10.5	12	T	T	T
			10			3	3	3	3	5	8.5	T	T	T
			16					2	2	3	5	8	13.5	T
			20						2	3	4.5	6.5	11	T
			25							2.5	4	6	9.5	T
32										4	6	9.5	T	
40											5	8	T	
50												5	9.5	
63													9.5	
K	15	≤2	T	T	T	T	T	T	T	T	T	T	T	
		3	T	T	T	T	T	T	T	T	T	T	T	
		4	T	T	T	T	T	T	T	T	T	T	T	
		6	5.5	5.5	5.5	5.5	5.5	5.5	10.5	T	T	T	T	
		8		5.5	5.5	5.5	5.5	5.5	10.5	12	T	T	T	
		10			3	3	3	3	6	8.5	T	T	T	
		16					3	3	4.5	7.5	10	13.5	T	
		20						3	3.5	5.5	6.5	11	T	
		25							3.5	5.5	6	9.5	T	
		32								4.5	6	9.5	T	
		40									5	8	T	
		50										6	9.5	
		63											9.5	





## Discrimination

Supply side circuit-breaker: MCCB

Load side circuit-breaker: MCB

Tmax T1 - S200P @ 400/415 V

Load s.	Char.	I <sub>cu</sub> [kA]	Supply s.	T1											
			Version	B, C, N											
			Release	TM											
			I <sub>n</sub> [A]	160											
			I <sub>n</sub> [A]	16	20	25	32	40	50	63	80	100	125	160	
S200P	C	25	≤2	T	T	T	T	T	T	T	T	T	T	T	T
			3	15	15	15	15	15	15	15	15	15	17*	T	T
			4	15	15	15	15	15	15	15	15	15	17*	T	T
			6	5.5	5.5	5.5	5.5	5.5	5.5	5.5	10.5	15	17*	T	T
			8		5.5	5.5	5.5	5.5	5.5	5.5	10.5	15	17*	T	T
			10			3	3	3	3	4.5	7.5	8.5	17*	T	T
			13				3	3	3	4.5	7.5	7.5	12	20*	T
			16					3	3	4.5	5	7.5	12	20*	T
			20						3	5	6	10	15	T	
	B-C	15	25							5	6	10	15	T	
			32								6	7.5	12	T	
			40									7.5	12	T	
			50										7.5	10.5	
			63											10.5	
			63												10.5
	D	25	≤2	T	T	T	T	T	T	T	T	T	T	T	T
			3	15	15	15	15	15	15	15	15	15	17*	T	T
			4	15	15	15	15	15	15	15	15	15	17*	T	T
			6	5.5	5.5	5.5	5.5	5.5	5.5	5.5	10.5	15	17*	T	T
			8		5.5	5.5	5.5	5.5	5.5	5.5	10.5	12	17*	T	T
			10			3	3	3	3	3	5	8.5	17*	T	T
			13						2	2	3	5	8	13.5	T
			16						2	2	3	5	8	13.5	T
			20							2	3	4.5	6.5	11	T
25									2.5	4	6	9.5	T		
15		32									4	6	9.5	T	
		40										5	8	T	
		50											5	9.5	
		63												9.5	
		63												9.5	
	63													9.5	

\* Select the lowest value between what is indicated and the breaking capacity of the supply side circuit-breaker



## Discrimination

Supply side circuit-breaker: MCCB

Load side circuit-breaker: MCB

Tmax T1 - S200P @ 400/415 V

Load s.	Char.	I <sub>cu</sub> [kA]	Supply s.	T1												
			Version	B, C, N												
			Release	TM												
			I <sub>n</sub> [A]	160												
			I <sub>n</sub> [A]	16	20	25	32	40	50	63	80	100	125	160		
S200P	K	25	≤2	T	T	T	T	T	T	T	T	T	T	T	T	
			3	15	15	15	15	15	15	15	15	15	17*	T	T	
			4	15	15	15	15	15	15	15	15	15	17*	T	T	
			6	5.5	5.5	5.5	5.5	5.5	5.5	5.5	10.5	15	17*	T	T	
			8		5.5	5.5	5.5	5.5	5.5	5.5	10.5	12	17*	T	T	
			10			3	3	3	3	3	6	8.5	17*	T	T	
		13							3	3	5	7.5	10	13.5	T	
		16							3	3	4.5	7.5	10	13.5	T	
		20								3	3.5	5.5	6.5	11	T	
		25									3.5	5.5	6	9.5	T	
		32										4.5	6	9.5	T	
		40											5	8	T	
	50												6	9.5		
	63													9.5		
	15															
	Z	25	≤2	T	T	T	T	T	T	T	T	T	T	T	T	
			3	15	15	15	15	15	15	15	15	15	15	17*	T	T
			4	15	15	15	15	15	15	15	15	15	15	17*	T	T
			6	5.5	5.5	5.5	5.5	5.5	5.5	5.5	5.5	10.5	15	17*	T	T
			8		5.5	5.5	5.5	5.5	5.5	5.5	5.5	10.5	12	17*	T	T
			10			3	3	3	3	4.5	8	8.5	17*	T	T	
		16							3	4.5	5	7.5	12	20*	T	
		20								3	5	6	10	15	T	
		25									5	6	10	15	T	
32											6	7.5	12	T		
40												7.5	12	T		
50													7.5	10.5		
63													10.5			

\* Select the lowest value between what is indicated and the breaking capacity of the supply side circuit-breaker



## Discrimination

Supply side circuit-breaker: MCCB

Load side circuit-breaker: MCB

**Tmax T1 - S500 @ 400/415 V**

Load s.	Char.	I <sub>cu</sub> [kA]	Supply s.	T1										
			Version	B, C, N										
			Release	TM										
			I <sub>n</sub> [A]	160										
			I <sub>n</sub> [A]	16	20	25	32	40	50	63	80	100	125	160
S500	B-C-D	50	6	5.5	5.5	5.5	5.5	5.5	5.5	10.5	15	20*	25*	T
			10			4.5	4.5	4.5	4.5	8	10	20*	25*	T
			13				4.5	4.5	4.5	7.5	10	15	25*	T
			16					4.5	4.5	7.5	10	15	25*	T
			20						4.5	7.5	10	15	25*	T
			25							6	10	15	20*	T
			32								7.5	10	20*	T
			40									10	20*	T
			50										15	T
			63											T
	K	50	≤5.8	36	36	T	T	T	T	T	T	T	T	T
			5.3..8	5.5	5.5	5.5	5.5	5.5	5.5	10.5	T	T	T	T
			7.3..11			4.5	4.5	4.5	4.5	8	T	T	T	T
		30	10..15				4.5	4.5	4.5	7.5	10	15	T	T
			14..20					4.5	4.5	7.5	10	15	T	T
			18..26						4.5	7.5	10	15	T	T
			23..32							6	10	15	20*	T
			29..37								7.5	10	20*	T
			34..41									10	20*	T
			38..45										15	T

\* Select the lowest value between what is indicated and the breaking capacity of the supply side circuit-breaker

2



## Discrimination

Supply side circuit-breaker: MCCB

Load side circuit-breaker: MCB

Tmax T2 - S200L @ 400/415 V

Load s.	Char.	I <sub>cu</sub> [kA]	Supply s.	T2																		
			Version	N, S, H, L																		
			Release	TM, M												EL						
			I <sub>u</sub> [A]	160																		
			I <sub>n</sub> [A]	12.5	16	20	25	32	40	50	63	80	100	125	160	10	25	63	100	160		
S200L	C	6	6	5.5*	5.5	5.5	5.5	5.5	5.5	5.5	5.5	T	T	T	T	T		T	T	T	T	
			8			5.5	5.5	5.5	5.5	5.5	5.5	T	T	T	T	T		T	T	T	T	T
			10			3*	3	3	3	4.5	T	T	T	T	T		T	T	T	T	T	T
			13			3*		3	3	4.5	T	T	T	T	T		T	T	T	T	T	T
			16					3*	3	4.5	5	T	T	T	T			T	T	T	T	T
			20					3*		3	5	T	T	T	T			T	T	T	T	T
			25							3*	5	T	T	T	T			T	T	T	T	T
			32								3*		T	T	T	T			T	T	T	T
			40									5.5*	T	T	T				T	T		

\* Value valid with supply side magnetic only circuit-breaker



# Discrimination

Supply side circuit-breaker: MCCB

Load side circuit-breaker: MCB

## Tmax T2 - S200 @ 400/415 V

Load s.	Char.	I <sub>cu</sub> [kA]	Supply s.	T2																				
			Version	N, S, H, L																				
			Release	TM, M										EL										
			I <sub>n</sub> [A]	160																				
			I <sub>n</sub> [A]	12.5	16	20	25	32	40	50	63	80	100	125	160	10	25	63	100	160				
S200	C	10	≤2	T	T	T	T	T	T	T	T	T	T	T	T	T	T	T	T	T	T			
			3	T	T	T	T	T	T	T	T	T	T	T	T	T	T	T	T	T	T	T		
			4	T	T	T	T	T	T	T	T	T	T	T	T	T	T	T	T	T	T	T	T	
			6	5.5*	5.5	5.5	5.5	5.5	5.5	5.5	5.5	5.5	T	T	T	T	T		T	T	T	T	T	
			8			5.5	5.5	5.5	5.5	5.5	5.5	T	T	T	T	T		T	T	T	T	T	T	
			10			3*	3	3	3	3	4.5	7.5	8.5	T	T	T		T	T	T	T	T	T	
			13			3*		3	3	4.5	7.5	7.5	T	T	T		T	T	T	T	T	T	T	
			16					3*	3	4.5	5	7.5	T	T	T				T	T	T	T	T	
			20						3*		3	5	6	T	T	T				T	T	T	T	
			25									3*	5	6	T	T	T				T	T	T	
			32										3*		6	7.5	T	T				T	T	T
			40												5.5*	7.5	T	T					T	T
	50													3*	5*	7.5	T					T	T	
	63														5*		T						T	
	D	10	≤2	T	T	T	T	T	T	T	T	T	T	T	T	T	T	T	T	T	T	T	T	
			3	T	T	T	T	T	T	T	T	T	T	T	T	T	T	T	T	T	T	T	T	T
			4	T	T	T	T	T	T	T	T	T	T	T	T	T	T	T	T	T	T	T	T	T
			6	5.5*	5.5	5.5	5.5	5.5	5.5	5.5	5.5	5.5	T	T	T	T	T		T	T	T	T	T	T
			8			5.5	5.5	5.5	5.5	5.5	5.5	T	T	T	T	T		T	T	T	T	T	T	T
			10			3*	3	3	3	3	3	5	8.5	T	T	T		T	T	T	T	T	T	T
			13					2*	2	2	3	5	8	T	T					T	T	T	T	T
			16					2*	2	2	3	5	8	T	T					T	T	T	T	T
			20					2*		2	3	4.5	6.5	T	T					T	T	T	T	T
			25								2*	2.5	4	6	9.5	T						T	T	T
			32											4	6	9.5	T					T	T	T
			40											3*	5	8	T						T	T
			50											2*	3*	5	9.5						9.5	9.5
			63												3*		9.5							

\* Value valid with supply side magnetic only circuit-breaker

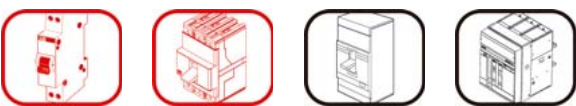

# Discrimination

Supply side circuit-breaker: MCCB

Load side circuit-breaker: MCB

**Tmax T2 - S200 @ 400/415 V**

Load s.	Char.	I <sub>cu</sub> [kA]	Supply s.	T2																			
			Version	N, S, H, L																			
			Release	TM, M												EL							
			I <sub>n</sub> [A]	160																			
			I <sub>n</sub> [A]	12.5	16	20	25	32	40	50	63	80	100	125	160	10	25	63	100	160			
S200	K	10	≤2	T	T	T	T	T	T	T	T	T	T	T	T	T	T	T	T	T	T		
			3	T	T	T	T	T	T	T	T	T	T	T	T	T	T	T	T	T	T	T	
			4	T	T	T	T	T	T	T	T	T	T	T	T	T	T	T	T	T	T	T	T
			6	5.5*	5.5	5.5	5.5	5.5	5.5	5.5	5.5	5.5	T	T	T	T	T		T	T	T	T	T
			8			5.5	5.5	5.5	5.5	5.5	5.5	T	T	T	T	T		T	T	T	T	T	T
			10			3*	3	3	3	3	3	6	8.5	T	T	T		T	T	T	T	T	T
			16						2*	3	3	4.5	7.5	T	T	T			T	T	T	T	T
			20						2*		3	3.5	5.5	6.5	T	T				T	T	T	T
			25								2*	3.5	5.5	6	9.5	T				T	T	T	T
			32										4.5	6	9.5	T				T	T	T	T
			40										3*	5	8	T					T	T	T
			50										2*	3*	6	9.5						9.5	9.5
	63											3*		9.5							9.5	9.5	
	Z	10	≤2	T	T	T	T	T	T	T	T	T	T	T	T	T	T	T	T	T	T	T	
			3	T	T	T	T	T	T	T	T	T	T	T	T	T	T	T	T	T	T	T	T
			4	T	T	T	T	T	T	T	T	T	T	T	T	T	T	T	T	T	T	T	T
			6	5.5*	5.5	5.5	5.5	5.5	5.5	5.5	5.5	5.5	T	T	T	T	T		T	T	T	T	T
			8			5.5	5.5	5.5	5.5	5.5	5.5	T	T	T	T	T		T	T	T	T	T	T
			10			3*	3	3	3	3	4.5	8	8.5	T	T	T		T	T	T	T	T	T
			16						3*	3	4.5	5	7.5	T	T	T				T	T	T	T
			20						3*		3	5	6	T	T	T				T	T	T	T
			25								3*	5	6	T	T	T				T	T	T	T
			32								3*		6	7.5	T	T				T	T	T	T
			40										5.5*	7.5	T	T						T	T
50												4*	5*	7.5	T						T	T	
63											5*		T								T		

\* Value valid with supply side magnetic only circuit-breaker



# Discrimination

Supply side circuit-breaker: MCCB

Load side circuit-breaker: MCB

**Tmax T2 - S200M @ 400/415 V**

Load s.	Char.	I <sub>cu</sub> [kA]	Supply s.	T2																		
			Version	N, S, H, L																		
			Release	TM, M										EL								
			I <sub>n</sub> [A]	160																		
			12.5	16	20	25	32	40	50	63	80	100	125	160	10	25	63	100	160			
S200M	C	15	≤2	T	T	T	T	T	T	T	T	T	T	T	T	T	T	T	T	T		
			3	T	T	T	T	T	T	T	T	T	T	T	T	T	T	T	T	T		
			4	T	T	T	T	T	T	T	T	T	T	T	T	T	T	T	T	T	T	
			6	5.5*	5.5	5.5	5.5	5.5	5.5	5.5	5.5	10.5	T	T	T	T		T	T	T	T	
			8			5.5	5.5	5.5	5.5	5.5	5.5	10.5	T	T	T	T		T	T	T	T	
			10			3*	3	3	3	3	4.5	7.5	8.5	T	T	T		T	T	T	T	
			13			3*		3	3	4.5	7.5	7.5	12	T	T			T	T	T	T	
			16					3*	3	4.5	5	7.5	12	T	T				T	T	T	
			20						3*		3	5	6	10	T	T				T	T	T
			25								3*	5	6	10	T	T				T	T	T
			32									3*		6	7.5	12	T			T	T	T
			40											5.5*	7.5	12	T				T	T
	50											3*	5*	7.5	10.5				10.5	10.5		
	63												5*		10.5					10.5		
	D	15	≤2	T	T	T	T	T	T	T	T	T	T	T	T	T	T	T	T	T		
			3	T	T	T	T	T	T	T	T	T	T	T	T	T	T	T	T	T	T	
			4	T	T	T	T	T	T	T	T	T	T	T	T	T	T	T	T	T	T	
			6	5.5*	5.5	5.5	5.5	5.5	5.5	5.5	5.5	10.5	T	T	T	T		T	T	T	T	
			8			5.5	5.5	5.5	5.5	5.5	5.5	10.5	12	T	T	T		T	T	T	T	
			10			3*	3	3	3	3	3	5	8.5	T	T	T		T	T	T	T	
			16					2*	2	2	3	5	8	13.5	T				T	T	T	
			20					2*		2	3	4.5	6.5	11	T				T	T	T	
			25							2*	2.5	4	6	9.5	T				T	T	T	
			32										4	6	9.5	T				T	T	T
			40										3*	5	8	T					T	T
			50										2*	3*	5	9.5					9.5	9.5
	63											3*		9.5						9.5		
	K	15	≤2	T	T	T	T	T	T	T	T	T	T	T	T	T	T	T	T	T		
			3	T	T	T	T	T	T	T	T	T	T	T	T	T	T	T	T	T	T	
			4	T	T	T	T	T	T	T	T	T	T	T	T	T	T	T	T	T	T	
			6	5.5*	5.5	5.5	5.5	5.5	5.5	5.5	5.5	10.5	T	T	T	T		T	T	T	T	
			8			5.5	5.5	5.5	5.5	5.5	5.5	10.5	12	T	T	T		T	T	T	T	
			10			3*	3	3	3	3	3	6	8.5	T	T	T		T	T	T	T	
			16					2*	3	3	4.5	7.5	10	13.5	T				T	T	T	
			20					2*		3	3.5	5.5	6.5	11	T				T	T	T	
			25							2*	3.5	5.5	6	9.5	T				T	T	T	
32												4.5	6	9.5	T				T	T	T	
40												3*	5	8	T					T	T	
50												2*	3*	6	9.5					9.5	9.5	
63											3*		9.5						9.5			

\* Value valid with supply side magnetic only circuit-breaker



2

# Discrimination

Supply side circuit-breaker: MCCB

Load side circuit-breaker: MCB

Tmax T2 - S200P @ 400/415 V

Load s.	Char.	I <sub>cu</sub> [kA]	Supply s.	T2																		
			Version	N, S, H, L																		
			Release	TM, M												EL						
			I <sub>n</sub> [A]	160																		
			I <sub>n</sub> [A]	12.5	16	20	25	32	40	50	63	80	100	125	160	10	25	63	100	160		
S200P	C	25	≤2	T	T	T	T	T	T	T	T	T	T	T	T	T	T	T	T	T	T	
			3	15	15	15	15	15	15	15	15	15	15	17	T	T	T	T	T	T	T	T
			4	15	15	15	15	15	15	15	15	15	15	17	T	T	T	T	T	T	T	T
			6	5.5*	5.5	5.5	5.5	5.5	5.5	5.5	5.5	10.5	15	17	T	T		T	T	T	T	T
			8			5.5	5.5	5.5	5.5	5.5	10.5	15	17	T	T		T	T	T	T	T	
			10			3*	3	3	3	4.5	7.5	8.5	17	T	T		T	T	T	T	T	
			13			3*		3	3	4.5	7.5	7.5	12	20	T		T	T	T	T	T	
			16					3*	3	4.5	5	7.5	12	20	T			T	T	T	T	
			20					3*		3	5	6	10	15	T				T	T	T	T
	B-C	15	32							3*		6	7.5	12	T			T	T	T	T	
			40									5.5*	7.5	12	T					T	T	
			50										3*	5*	7.5	10.5				10.5	10.5	
			63											5*		10.5					10.5	
			≤2	T	T	T	T	T	T	T	T	T	T	T	T	T	T	T	T	T	T	T
			3	15	15	15	15	15	15	15	15	15	15	15	17	T	T	T	T	T	T	T
	4	15	15	15	15	15	15	15	15	15	15	15	17	T	T	T	T	T	T	T	T	
	6	5.5*	5.5	5.5	5.5	5.5	5.5	5.5	5.5	10.5	15	17	T	T		T	T	T	T	T		
	8			5.5	5.5	5.5	5.5	5.5	10.5	12	17	T	T		T	T	T	T	T			
	10			3*	3	3	3	3	5	8.5	17	T	T		T	T	T	T	T			
	13					2*	2	2	3	5	8	13.5	T				T	T	T	T		
	16					2*	2	2	3	5	8	13.5	T				T	T	T	T		
	20					2*		2	3	4.5	6.5	11	T				T	T	T	T		
	25							2*	2.5	4	6	9.5	T				T	T	T	T		
	D	15	32									4	6	9.5	T			T	T	T	T	
40											3*	5	8	T				T	T	T		
50											2*	3*	5	9.5				9.5	9.5	9.5		
63												3*		9.5						9.5		

\* Value valid with supply side magnetic only circuit-breaker





# Discrimination

Supply side circuit-breaker: MCCB

Load side circuit-breaker: MCB

**Tmax T2 - S200P @ 400/415 V**

Load s.	Char.	I <sub>cu</sub> [kA]	Supply s.	T2																		
			Version	N, S, H, L																		
			Release	TM, M												EL						
			I <sub>n</sub> [A]	160																		
			I <sub>n</sub> [A]	12.5	16	20	25	32	40	50	63	80	100	125	160	10	25	63	100	160		
S200P	K	25	≤2	T	T	T	T	T	T	T	T	T	T	T	T	T	T	T	T	T	T	
			3	15	15	15	15	15	15	15	15	15	15	17	T	T	T	T	T	T	T	T
			4	15	15	15	15	15	15	15	15	15	15	17	T	T	T	T	T	T	T	T
			6	5.5*	5.5	5.5	5.5	5.5	5.5	5.5	5.5	10.5	15	17	T	T		T	T	T	T	T
			8			5.5	5.5	5.5	5.5	5.5	5.5	10.5	12	17	T	T		T	T	T	T	T
			10			3*	3	3	3	3	3	6	8.5	17	T	T		T	T	T	T	T
			13					2*	3	3	3	5	7.5	10	13.5	T		T	T	T	T	T
		16					2*	3	3	4.5	7.5	10	13.5	T			T	T	T	T	T	
		20					2*		3	3.5	5.5	6.5	11	T			T	T	T	T	T	
		25								2*	3.5	5.5	6	9.5	T			T	T	T	T	
		32										4.5	6	9.5	T			T	T	T	T	
		40										3*	5	8	T				T	T	T	
		50										2*	3*	6	9.5					9.5	9.5	
		63											3*		9.5						9.5	
		Z	25	≤2	T	T	T	T	T	T	T	T	T	T	T	T	T	T	T	T	T	T
	3			15	15	15	15	15	15	15	15	15	15	17	T	T	T	T	T	T	T	T
	4			15	15	15	15	15	15	15	15	15	15	17	T	T	T	T	T	T	T	T
	6			5.5*	5.5	5.5	5.5	5.5	5.5	5.5	5.5	10.5	15	17	T	T		T	T	T	T	T
	8					5.5	5.5	5.5	5.5	5.5	10.5	15	17	T	T		T	T	T	T	T	T
	10					3*	3	3	3	4.5	8	8.5	17	T	T		T	T	T	T	T	T
	16							3*	3	4.5	5	7.5	12	20	T			T	T	T	T	T
	20						3*		3	5	6	10	15	T			T	T	T	T	T	
	25								3*	5	6	10	15	T			T	T	T	T	T	
	32									3*		6	7.5	12	T			T	T	T	T	
	40											5.5*	7.5	12	T				T	T	T	
	50											4*	5*	7.5	10.5					10.5	10.5	
	63												5*		10.5						10.5	

\* Value valid with supply side magnetic only circuit-breaker



2

## Discrimination

Supply side circuit-breaker: MCCB

Load side circuit-breaker: MCB

### Tmax T2 - S290 @ 400/415 V

			Supply s.	T2	
			Version	N, S, H, L	
			Release	TM, M	EL
			I <sub>u</sub> [A]	160	
Load s.	Char.	I <sub>cu</sub> [kA]	I <sub>n</sub> [A]	160	160
S290	C-D-K	15	80		4
			100		4
	C		125		4

### Tmax T2 - S500 @ 400/415 V

			Supply s.	T2																	
			Version	N, S, H, L																	
			Release	TM, M												EL					
			I <sub>u</sub> [A]	160																	
Load s.	Char.	I <sub>cu</sub> [kA]	I <sub>n</sub> [A]	12.5	16	20	25	32	40	50	63	80	100	125	160	10	25	63	100	160	
S500	B-C-D	50	6	4.5	5.5	5.5	5.5	5.5	5.5	5.5	5.5	10.5	15	20	25	36		36	36	36	36
			10			4.5*	4.5	4.5	4.5	4.5	4.5	8	10	20	25	36		36	36	36	36
			13			4.5*		4.5	4.5	4.5	4.5	7.5	10	15	25	36		36	36	36	36
			16					4.5*	4.5	4.5	4.5	7.5	10	15	25	36			36	36	36
			20					4.5*		4.5	4.5	7.5	10	15	25	36			36	36	36
			25								4.5*	6	10	15	20	36			36	36	36
			32								4.5*		7.5	10	20	36			36	36	36
			40										5*	10	20	36				36	36
			50										5*	7.5*	15	36				36	36
	63											5*	36						36		
	K	30	≤5.8	36	36	36	36	36	36	36	36	36	36	36	36	50**	50**	50**	50**	50**	50**
			5.3..8	4.5*	5.5	5.5	5.5	5.5	5.5	5.5	10.5	36	36	36	50**		50**	50**	50**	50**	
			7.3..11			4.5*	4.5	4.5	4.5	4.5	8	36	36	36	50**		50**	50**	50**	50**	
			10..15			4.5*		4.5	4.5	4.5	7.5	10	15	T	T		T	T	T	T	
			14..20					4.5*	4.5	4.5	7.5	10	15	T	T			T	T	T	
			18..26					4.5*		4.5	7.5	10	15	T	T			T	T	T	
			23..32							4.5*	6	10	15	20	T			T	T	T	
			29..37							4.5*		7.5	10	20	T					T	T
34..41											5*	10	20	T					T	T	
38..45									5*	7.5*	15	T					T	T			

\* Value valid with supply side magnetic only circuit-breaker

\*\* Select the lowest value between what is indicated and the breaking capacity of the supply side circuit-breaker



## Discrimination

Supply side circuit-breaker: MCCB

Load side circuit-breaker: MCB

**Tmax T3 - S200L@ 400/415 V**

Load s.	Char.	I <sub>cu</sub> [kA]	Supply s.								
			I <sub>n</sub> [A]	63	80	100	125	160	200	250	
S200L	C	6	6	T	T	T	T	T	T	T	T
			8	T	T	T	T	T	T	T	T
			10	T	T	T	T	T	T	T	T
			13	T	T	T	T	T	T	T	T
			16	5	T	T	T	T	T	T	T
			20	5	T	T	T	T	T	T	T
			25	5	T	T	T	T	T	T	T
			32		T	T	T	T	T	T	T
			40		4	T	T	T	T	T	T

2



## Discrimination

Supply side circuit-breaker: MCCB

Load side circuit-breaker: MCB

Tmax T3 - S200 @ 400/415 V

Load s.	Char.	I <sub>cu</sub> [kA]	Supply s.							
			T3							
			Version							
			N, S							
			Release							
			TM, M							
			I <sub>u</sub> [A]							
			250							
			I <sub>n</sub> [A]	63	80	100	125	160	200	250
S200	C	10	≤2	T	T	T	T	T	T	T
			3	T	T	T	T	T	T	T
			4	T	T	T	T	T	T	T
	6		T	T	T	T	T	T	T	
	8		T	T	T	T	T	T	T	
	10		7.5	8.5	T	T	T	T	T	
	13		7.5	7.5	T	T	T	T	T	
	16		5	7.5	T	T	T	T	T	
	20		5	6	T	T	T	T	T	
	25		5	6	T	T	T	T	T	
	32			6	7.5	T	T	T	T	
	40				7.5	T	T	T	T	
	50			5*	7.5	T	T	T		
	63			5*	6*	T	T	T		
	D	10	≤2	T	T	T	T	T	T	T
			3	T	T	T	T	T	T	T
			4	T	T	T	T	T	T	T
			6	T	T	T	T	T	T	T
			8	T	T	T	T	T	T	T
			10	5	8.5	T	T	T	T	
			13	3	5	8	T	T	T	
			16	3	5	8	T	T	T	
			20	3	4.5	6.5	T	T	T	
			25	2.5	4	6	9.5	T	T	
			32		4	6	9.5	T	T	
			40			5	8	T	T	
			50			3*	5	9.5	T	
			63			3*	5*	9.5	T	

\* Value valid with supply side magnetic only circuit-breaker



## Discrimination

Supply side circuit-breaker: MCCB

Load side circuit-breaker: MCB

### Tmax T3 - S200 @ 400/415 V

Load s.	Char.	I <sub>cu</sub> [kA]	Supply s.							
			T3							
			N, S							
			Release							
			TM, M							
			I <sub>u</sub> [A]							
			250							
			I <sub>n</sub> [A]	63	80	100	125	160	200	250
S200	K	10	≤2	T	T	T	T	T	T	T
			3	T	T	T	T	T	T	T
			4	T	T	T	T	T	T	T
			6	T	T	T	T	T	T	T
			8	T	T	T	T	T	T	T
			10	6	8.5	T	T	T	T	T
			16	4.5	7.5	T	T	T	T	T
			20	3.5	5.5	6.5	T	T	T	T
			25	3.5	5.5	6	9.5	T	T	T
			32		4.5	6	9.5	T	T	T
	40			5	8	T	T	T		
	50			3*	6	9.5	T	T		
	63			3*	5.5*	9.5	T	T		
	Z	10	≤2	T	T	T	T	T	T	T
			3	T	T	T	T	T	T	T
			4	T	T	T	T	T	T	T
			6	T	T	T	T	T	T	T
			8	T	T	T	T	T	T	T
			10	8	8.5	T	T	T	T	T
			16	5	7.5	T	T	T	T	T
20			5	6	T	T	T	T	T	
25			5	6	T	T	T	T	T	
32				6	7.5	T	T	T	T	
40			7.5	T	T	T	T			
50			5*	7.5	T	T	T			
63			5*	6*	T	T	T			

\* Value valid with supply side magnetic only circuit-breaker



## Discrimination

Supply side circuit-breaker: MCCB

Load side circuit-breaker: MCB

Tmax T3 - S200M @ 400/415 V

Load s.	Char.	I <sub>cu</sub> [kA]	Supply s.							
			T3							
			Version							
			Release							
			TM, M							
			I <sub>u</sub> [A]							
			250							
			I <sub>n</sub> [A]	63	80	100	125	160	200	250
S200M	C	15	≤2	T	T	T	T	T	T	T
			3	T	T	T	T	T	T	T
			4	T	T	T	T	T	T	T
	6		10.5	T	T	T	T	T	T	
	8		10.5	T	T	T	T	T	T	
	10		7.5	8.5	T	T	T	T	T	
	13		7.5	7.5	12	T	T	T	T	
	16		5	7.5	12	T	T	T	T	
	20		5	6	10	T	T	T	T	
	25		5	6	10	T	T	T	T	
	32			6	7.5	12	T	T	T	
	40				7.5	12	T	T	T	
	50			5*	7.5	10.5	T	T		
	63			5*	6*	10.5	T	T		
	B-C	15	≤2	T	T	T	T	T	T	T
			3	T	T	T	T	T	T	T
			4	T	T	T	T	T	T	T
			6	10.5	T	T	T	T	T	T
			8	10.5	12	T	T	T	T	T
			10	5	8.5	T	T	T	T	T
			16	3	5	8	13.5	T	T	T
			20	3	4.5	6.5	11	T	T	T
			25	2.5	4	6	9.5	T	T	T
			32		4	6	9.5	T	T	T
			40			5	8	T	T	T
			50			3*	5	9.5	T	T
	63			3*	5*	9.5	T	T		
	D	15	≤2	T	T	T	T	T	T	T
			3	T	T	T	T	T	T	T
			4	T	T	T	T	T	T	T
			6	10.5	T	T	T	T	T	T
			8	10.5	12	T	T	T	T	T
			10	6	8.5	T	T	T	T	T
			16	4.5	7.5	10	13.5	T	T	T
			20	3.5	5.5	6.5	11	T	T	T
			25	3.5	5.5	6	9.5	T	T	T
32				4.5	6	9.5	T	T	T	
40					5	8	T	T	T	
50					3*	6	9.5	T	T	
63			3*	5.5*	9.5	T	T			
K	15	≤2	T	T	T	T	T	T	T	
		3	T	T	T	T	T	T	T	
		4	T	T	T	T	T	T	T	
		6	10.5	T	T	T	T	T	T	
		8	10.5	12	T	T	T	T	T	
		10	6	8.5	T	T	T	T	T	
		16	4.5	7.5	10	13.5	T	T	T	
		20	3.5	5.5	6.5	11	T	T	T	
		25	3.5	5.5	6	9.5	T	T	T	
		32		4.5	6	9.5	T	T	T	
		40			5	8	T	T	T	
		50			3*	6	9.5	T	T	
63			3*	5.5*	9.5	T	T			

\* Value valid with supply side magnetic only circuit-breaker



## Discrimination

Supply side circuit-breaker: MCCB

Load side circuit-breaker: MCB

**Tmax T3 - S200P @ 400/415 V**

Load s.	Char.	I <sub>cu</sub> [kA]	Supply s.	T3							
			Version	N, S							
			Release	TM, M							
			I <sub>n</sub> [A]	250							
			I <sub>n</sub> [A]	63	80	100	125	160	200	250	
S200P	C	25	≤2	T	T	T	T	T	T	T	T
			3	15	15	17	T	T	T	T	
			4	15	15	17	T	T	T	T	
	6		10.5	15	17	T	T	T	T		
	8		10.5	15	17	T	T	T	T		
	10		7.5	8.5	17	T	T	T	T		
	13		7.5	7.5	12	20	T	T	T		
	16		5	7.5	12	20	T	T	T		
	20		5	6	10	15	T	T	T		
	25	5	6	10	15	T	T	T			
	15	32		6	7.5	12	T	T	T		
		40			7.5	12	T	T	T		
		50			5*	7.5	10.5	T	T		
		63			5*	6*	10.5	T	T		
		≤2	T	T	T	T	T	T	T		
		3	15	15	T	T	T	T	T		
	4	15	15	T	T	T	T	T			
	6	10.5	15	T	T	T	T	T			
	8	10.5	12	T	T	T	T	T			
	10	5	8.5	T	T	T	T	T			
	13	3	5	8	13.5	T	T	T			
	16	3	5	8	13.5	T	T	T			
	20	3	4.5	6.5	11	T	T	T			
	25	2.5	4	6	9.5	T	T	T			
15	32		4	6	9.5	T	T	T			
	40			5	8	T	T	T			
	50			3*	5	9.5	T	T			
	63			3*	5*	9.5	T	T			

\* Value valid with supply side magnetic only circuit-breaker



## Discrimination

Supply side circuit-breaker: MCCB

Load side circuit-breaker: MCB

Tmax T3 - S200P @ 400/415 V

Load s.	Char.	I <sub>cu</sub> [kA]	Supply s.									
			T3									
			Version									
			N, S									
			Release									
			TM, M									
			I <sub>u</sub> [A]									
			250									
			I <sub>n</sub> [A]	63	80	100	125	160	200	250		
S200P	K	25	≤2	T	T	T	T	T	T	T		
			3	15	15	17	T	T	T	T		
			4	15	15	17	T	T	T	T		
			6	10.5	15	17	T	T	T	T		
			8	10.5	12	17	T	T	T	T		
			10	6	8.5	17	T	T	T	T		
			13	5	7.5	10	13.5	T	T	T		
			16	4.5	7.5	10	13.5	T	T	T		
			20	3.5	5.5	6.5	11	T	T	T		
		25	3.5	5.5	6	9.5	T	T	T			
		15	32		4.5	6	9.5	T	T	T		
			40			5	8	T	T	T		
			50			3*	6	9.5	T	T		
			63			3*	5.5*	9.5	T	T		
			Z	25	≤2	T	T	T	T	T	T	T
					3	15	15	17	T	T	T	T
					4	15	15	17	T	T	T	T
					6	10.5	15	17	T	T	T	T
	8				10.5	15	17	T	T	T	T	
	10	8			8.5	17	T	T	T	T		
	16	5			7.5	12	20	T	T	T		
	20	5			6	10	15	T	T	T		
	25	5			6	10	15	T	T	T		
	15	32		6	7.5	12	T	T	T			
		40			7.5	12	T	T	T			
		50			5*	7.5	10.5	T	T			
		63			5*	6*	10.5	T	T			

\* Value valid with supply side magnetic only circuit-breaker





## Discrimination

Supply side circuit-breaker: MCCB

Load side circuit-breaker: MCB

### Tmax T3 - S290 @ 400/415 V

			Supply s.	T3		
			Version	N, S		
			Release	TM, M		
			I <sub>u</sub> [A]	250		
Load s.	Char.	I <sub>cu</sub> [kA]	I <sub>n</sub> [A]	160	200	250
S290	C-D-K	15	80	4*	10	15
			100	4*	7.5*	15
	C		125		7.5*	

\* Value valid with supply side magnetic only circuit-breaker

### Tmax T3 - S500 @ 400/415 V

			Supply s.	T3						
			Version	N, S						
			Release	TM, M						
			I <sub>u</sub> [A]	250						
Load s.	Char.	I <sub>cu</sub> [kA]	I <sub>n</sub> [A]	63	80	100	125	160	200	250
S500	B-C-D	50	6	10.5	15	20	25	36	36	36
			10	8	10	20	25	36	36	36
			13	7.5	10	15	25	36	36	36
			16	7.5	10	15	25	36	36	36
			20	7.5	10	15	25	36	36	36
			25	6	10	15	20	36	36	36
			32		7.5	10	20	36	36	36
			40			10	20	36	36	36
			50			7.5*	15	36	36	36
			63			5*	6*	36	36	36
	K	50	≤5.8	36	36	36	36	T	T	T
			5.3..8	10.5	36	36	36	T	T	T
			7.3..11	8	36	36	36	T	T	T
			10..15	7.5	10	15	T	T	T	T
			14..20	7.5	10	15	T	T	T	T
		30	18..26	7.5	10	15	T	T	T	T
			23..32	6	10	15	20	T	T	T
			29..37		7.5	10	20	T	T	T
			34..41			10	20	T	T	T
			38..45			7.5*	15	T	T	T

\* Value valid with supply side magnetic only circuit-breaker



## Discrimination

Supply side circuit-breaker: MCCB

Load side circuit-breaker: MCB

Tmax T4 - S200L @ 400/415 V

Load s.	Char.	I <sub>cu</sub> [kA]	Supply s.	T4													
			Version	N, S, H, L, V													
			Release	TM, M										EL			
			I <sub>u</sub> [A]	250										250		320	
I <sub>n</sub> [A]	20	25	32	50	80	100	125	160	200	250	100	160	250	320			
S200L	C	6	6	T	T*	T	T	T	T	T	T	T	T	T	T	T	
			8	T	T*	T	T	T	T	T	T	T	T	T	T		
			10	5	5*	5	T	T	T	T	T	T	T	T	T	T	
			13		5*	5	T	T	T	T	T	T	T	T	T	T	
			16		3*	5	T	T	T	T	T	T	T	T	T	T	
			20				5	T	T	T	T	T	T	T	T	T	
			25				5	T	T	T	T	T	T	T	T	T	
			32				5**	T	T	T	T	T	T	T	T	T	
40					T	T	T	T	T	T	T	T	T				

\* Value valid with supply side magnetic only circuit-breaker

\*\* Value valid with supply side magnetic only MA 52 circuit-breaker



# Discrimination

Supply side circuit-breaker: MCCB

Load side circuit-breaker: MCB

**Tmax T4 - S200 @ 400/415 V**

Load s.	Char.	I <sub>cu</sub> [kA]	Supply s.	T4														
			Version	N, S, H, L, V														
			Release	TM, M										EL				
			I <sub>n</sub> [A]	250										250		320		
			20	25	32	50	80	100	125	160	200	250	100	160	250	320		
S200	C	10	≤2	T	T*	T	T	T	T	T	T	T	T	T	T	T	T	
			3	T	T*	T	T	T	T	T	T	T	T	T	T	T	T	
			4	T	T*	T	T	T	T	T	T	T	T	T	T	T	T	T
			6	7.5	7.5*	7.5	7.5	T	T	T	T	T	T	T	T	T	T	T
			8	7.5	7.5*	7.5	7.5	T	T	T	T	T	T	T	T	T	T	T
			10	5	5*	5	6.5	9	T	T	T	T	T	T	T	T	T	T
			13		5*	5	6.5	8	T	T	T	T	T	T	T	T	T	T
			16		3*	5	6.5	8	T	T	T	T	T	T	T	T	T	T
			20				5	7.5	T	T	T	T	T	T	T	T	T	T
			25				5	7.5	T	T	T	T	T	T	T	T	T	T
			32				5**	7.5	T	T	T	T	T	T	T	T	T	T
			40					6.5	T	T	T	T	T	T	T	T	T	T
	50					5*	T	T	T	T	T	T	T	T	T	T		
	63						T*	T*	T	T	T	T	T	T	T	T		
	D	10	≤2	T	T*	T	T	T	T	T	T	T	T	T	T	T	T	
			3	T	T*	T	T	T	T	T	T	T	T	T	T	T	T	
			4	T	T*	T	T	T	T	T	T	T	T	T	T	T	T	
			6	7.5	7.5*	7.5	7.5	T	T	T	T	T	T	T	T	T	T	
			8	7.5	7.5*	7.5	7.5	T	T	T	T	T	T	T	T	T	T	
			10	5	5*	5	5	9	T	T	T	T	T	T	T	T	T	
			13		5*		4	5.5	T	T	T	T	T	T	T	T	T	
			16				4	5.5	T	T	T	T	T	T	T	T	T	
			20				4**	5	T	T	T	T	T	T	T	T	T	
			25				4**	4.5	T	T	T	T	T	T	T	T	T	
			32					4.5*	T	T	T	T	T	T	T	T	T	
			40					4.5*	T*	T	T	T	T	T	T	T	T	
			50						T*	T*	T	T	T	T	T	T	T	
			63							T*	T*	T	T	T	T	T	T	

\* Value valid with supply side magnetic only circuit-breaker  
 \*\* Value valid with supply side magnetic only MA 52 circuit-breaker



# Discrimination

Supply side circuit-breaker: MCCB

Load side circuit-breaker: MCB

Tmax T4 - S200 @ 400/415 V

Load s.	Char.	I <sub>cu</sub> [kA]	Supply s.	T4															
			Version	N, S, H, L, V															
			Release	TM, M										EL					
			I <sub>n</sub> [A]	250										250		320			
			20	25	32	50	80	100	125	160	200	250	100	160	250	320			
S200	K	10	≤2	T	T*	T	T	T	T	T	T	T	T	T	T	T	T		
			3	T	T*	T	T	T	T	T	T	T	T	T	T	T	T	T	
			4	T	T*	T	T	T	T	T	T	T	T	T	T	T	T	T	T
			6	7.5	7.5*	7.5	7.5	T	T	T	T	T	T	T	T	T	T	T	T
			8	7.5	7.5*	7.5	7.5	T	T	T	T	T	T	T	T	T	T	T	T
			10		5*	5	5	9	T	T	T	T	T	T	T	T	T	T	T
			16		5*		5	8	T	T	T	T	T	T	T	T	T	T	T
			20				5	6	T	T	T	T	T	T	T	T	T	T	T
			25				5**	6*	T	T	T	T	T	T	T	T	T	T	T
			32				5**	6*	T*	T	T	T	T	T	T	T	T	T	T
	40					5.5*	T*	T*	T	T	T	T	T	T	T	T	T		
	50					5*	T*	T*	T*	T	T	T	T	T	T	T	T		
	63						T*	T*	T*	T*	T	T	T	T	T	T	T		
	Z	10	≤2	T	T*	T	T	T	T	T	T	T	T	T	T	T	T	T	
			3	T	T*	T	T	T	T	T	T	T	T	T	T	T	T	T	
			4	T	T*	T	T	T	T	T	T	T	T	T	T	T	T	T	T
			6	7.5	7.5*	7.5	7.5	T	T	T	T	T	T	T	T	T	T	T	T
			8	7.5	7.5*	7.5	7.5	T	T	T	T	T	T	T	T	T	T	T	T
			10	5	5*	5	6.5	9	T	T	T	T	T	T	T	T	T	T	T
			16		5*	4.5	6.5	8	T	T	T	T	T	T	T	T	T	T	T
20						5	7.5	T	T	T	T	T	T	T	T	T	T	T	
25						5	7.5	T	T	T	T	T	T	T	T	T	T	T	
32						5**	7.5	T	T	T	T	T	T	T	T	T	T	T	
40					6.5	T	T	T	T	T	T	T	T	T	T	T			
50					5*	T	T	T	T	T	T	T	T	T	T	T			
63						T*	T	T	T	T	T	T	T	T	T	T			

\* Value valid with supply side magnetic only circuit-breaker

\*\* Value valid with supply side magnetic only MA 52 circuit-breaker



# Discrimination

Supply side circuit-breaker: MCCB

Load side circuit-breaker: MCB

**Tmax T4 - S200M @ 400/415 V**

Load s.	Char.	I <sub>cu</sub> [kA]	Supply s.	T4																
			Version	N, S, H, L, V																
			Release	TM, M										EL						
			I <sub>n</sub> [A]	250										250		320				
			I <sub>n</sub> [A]	20	25	32	50	80	100	125	160	200	250	100	160	250	320			
S200M	C	15	≤2	T	T*	T	T	T	T	T	T	T	T	T	T	T	T	T		
			3	T	T*	T	T	T	T	T	T	T	T	T	T	T	T	T	T	
			4	T	T*	T	T	T	T	T	T	T	T	T	T	T	T	T	T	T
			6	7.5	7.5*	7.5	7.5	T	T	T	T	T	T	T	T	T	T	T	T	T
			8	7.5	7.5*	7.5	7.5	T	T	T	T	T	T	T	T	T	T	T	T	T
			10	5	5*	5	6.5	9	T	T	T	T	T	T	T	T	T	T	T	T
			13		5*	5	6.5	8	T	T	T	T	T	T	T	T	T	T	T	T
			16		3*	5	6.5	8	T	T	T	T	T	T	T	T	T	T	T	T
			20				5	7.5	T	T	T	T	T	T	T	T	T	T	T	T
			25				5	7.5	T	T	T	T	T	T	T	T	T	T	T	T
			32					5**	7.5	T	T	T	T	T	T	T	T	T	T	T
			40						6.5	T	T	T	T	T	T	T	T	T	T	T
	50						5*	T	T	T	T	T	T	T	T	T	T	T		
	63							T*	T*	T	T	T	T	T	T	T	T	T		
	D	15	≤2	T	T*	T	T	T	T	T	T	T	T	T	T	T	T	T	T	
			3	T	T*	T	T	T	T	T	T	T	T	T	T	T	T	T	T	
			4	T	T*	T	T	T	T	T	T	T	T	T	T	T	T	T	T	
			6	7.5	7.5*	7.5	7.5	T	T	T	T	T	T	T	T	T	T	T	T	
			8	7.5	7.5*	7.5	7.5	T	T	T	T	T	T	T	T	T	T	T	T	
			10	5	5*	5	5	9	T	T	T	T	T	T	T	T	T	T	T	
			16				4	5.5	T	T	T	T	T	T	T	T	T	T	T	
			20				4**	5	T	T	T	T	T	T	T	T	T	T	T	
			25				4**	4.5	T	T	T	T	T	T	T	T	T	T	T	
			32					4.5*	T	T	T	T	T	T	T	T	T	T	T	
			40					4.5*	T*	T	T	T	T	T	T	T	T	T	T	
			50						T*	T*	T	T	T	T	T	T	T	T	T	
	63							T*	T*	T	T	T	T	T	T	T	T			
	K	15	≤2	T	T*	T	T	T	T	T	T	T	T	T	T	T	T	T	T	
			3	T	T*	T	T	T	T	T	T	T	T	T	T	T	T	T	T	
			4	T	T*	T	T	T	T	T	T	T	T	T	T	T	T	T	T	
			6	7.5	7.5*	7.5	7.5	T	T	T	T	T	T	T	T	T	T	T	T	
			8	7.5	7.5*	7.5	7.5	T	T	T	T	T	T	T	T	T	T	T	T	
			10		5*	5	5	9	T	T	T	T	T	T	T	T	T	T	T	
			16		5*		5	8	T	T	T	T	T	T	T	T	T	T	T	
			20				5	6	T	T	T	T	T	T	T	T	T	T	T	
			25				5**	6*	T	T	T	T	T	T	T	T	T	T	T	
32						5**	6*	T*	T	T	T	T	T	T	T	T	T	T		
40							5.5*	T*	T*	T	T	T	T	T	T	T	T	T		
50							5*	T*	T*	T*	T	T	T	T	T	T	T	T		
63						T*	T*	T*	T*	T	T	T	T	T	T	T				

\* Value valid with supply side magnetic only circuit-breaker  
 \*\* Value valid with supply side magnetic only MA 52 circuit-breaker

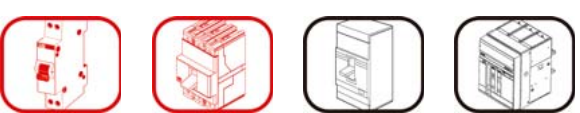

# Discrimination

Supply side circuit-breaker: MCCB

Load side circuit-breaker: MCB

Tmax T4 - S200P @ 400/415 V

Load s.	Char.	I <sub>cu</sub> [kA]	Supply s.	T4																
			Version	N, S, H, L, V																
			Release	TM, M										EL						
			I <sub>n</sub> [A]	250										250		320				
			20	25	32	50	80	100	125	160	200	250	100	160	250	320				
S200P	C	25	≤2	T	T*	T	T	T	T	T	T	T	T	T	T	T	T			
			3	15	15*	15	15	15	15	T	T	T	T	T	T	T	T	T		
			4	15	15*	15	15	15	15	T	T	T	T	T	T	T	T	T	T	
			6	7.5	7.5*	7.5	7.5	7.5	15	T	T	T	T	T	T	T	T	T	T	
			8	7.5	7.5*	7.5	7.5	7.5	15	T	T	T	T	T	T	T	T	T	T	
			10	5	5*	5	6.5	9	9	T	T	T	T	T	T	T	T	T	T	T
			13		5*	5	6.5	8	8	T	T	T	T	T	T	T	T	T	T	T
			16		3*	5	6.5	8	8	T	T	T	T	T	T	T	T	T	T	T
			20				5	7.5	7.5	7.5	T	T	T	T	T	T	T	T	T	T
	25				5	7.5	7.5	7.5	T	T	T	T	T	T	T	T	T	T		
	B-C	15	32				5**	7.5	7.5	7.5	7.5	7.5	7.5	T	T	T	T	T		
			40					6.5	6.5	6.5	6.5	6.5	6.5	T	T	T	T	T		
			50					5*	5	5	5	5	5	T	T	T	T	T		
			63						T*	T*	T	T	T	T	T	T	T	T		
			≤2	T	T*	T	T	T	T	T	T	T	T	T	T	T	T	T	T	
			3	15	15*	15	15	15	15	T	T	T	T	T	T	T	T	T	T	
	D	25	4	15	15*	15	15	15	15	T	T	T	T	T	T	T	T	T		
			6	7.5	7.5*	7.5	7.5	7.5	15	T	T	T	T	T	T	T	T	T		
			8	7.5	7.5*	7.5	7.5	7.5	15	T	T	T	T	T	T	T	T	T		
			10	5	5*	5	5	9	9	T	T	T	T	T	T	T	T	T		
			13		5*		4	5.5	5.5	T	T	T	T	T	T	T	T	T		
			16				4	5.5	5.5	T	T	T	T	T	T	T	T	T		
			20				4**	5	5	T	T	T	T	T	T	T	T	T		
			25				4**	4.5	4.5	T	T	T	T	T	T	T	T	T		
15			32					4.5*	4.5	T	T	T	T	T	T	T	T	T		
		40					4.5*	4.5	T*	T	T	T	T	T	T	T	T			
		50							T*	T*	T	T	T	T	T	T				
		63								T*	T*	T	T	T	T	T				
		≤2	T	T*	T	T	T	T	T	T	T	T	T	T	T	T	T			
		3	15	15*	15	15	15	15	T	T	T	T	T	T	T	T				

\* Value valid with supply side magnetic only circuit-breaker

\*\* Value valid with supply side magnetic only MA 52 circuit-breaker



# Discrimination

Supply side circuit-breaker: MCCB

Load side circuit-breaker: MCB

**Tmax T4 - S200P @ 400/415 V**

Load s.	Char.	I <sub>cu</sub> [kA]	Supply s.	T4															
			Version	N, S, H, L, V															
			Release	TM, M										EL					
			I <sub>n</sub> [A]	250										250		320			
			20	25	32	50	80	100	125	160	200	250	100	160	250	320			
S200P	K	25	≤2	T	T*	T	T	T	T	T	T	T	T	T	T	T	T		
			3	15	15*	15	15	15	T	T	T	T	T	T	T	T	T	T	
			4	15	15*	15	15	15	T	T	T	T	T	T	T	T	T	T	T
			6	7.5	7.5*	7.5	7.5	15	T	T	T	T	T	T	T	T	T	T	T
			8	7.5	7.5*	7.5	7.5	15	T	T	T	T	T	T	T	T	T	T	T
			10		5*	5	5	9	T	T	T	T	T	T	T	T	T	T	T
		13		5*	5	5	8	T	T	T	T	T	T	T	T	T	T	T	
		16		5*		5	8	T	T	T	T	T	T	T	T	T	T	T	
		20				5	6	T	T	T	T	T	T	T	T	T	T	T	
		25				5**	6*	T	T	T	T	T	T	T	T	T	T	T	
		32				5**	6*	T*	T	T	T	T	T	T	T	T	T	T	
		40					5.5*	T*	T*	T	T	T	T	T	T	T	T	T	
	50					5*	T*	T*	T*	T	T	T	T	T	T	T	T		
	63						T*	T*	T*	T*	T	T	T	T	T	T	T		
	25	Z	≤2	T	T*	T	T	T	T	T	T	T	T	T	T	T	T	T	
	3		15	15*	15	15	15	T	T	T	T	T	T	T	T	T	T	T	
	4		15	15*	15	15	15	T	T	T	T	T	T	T	T	T	T	T	
	6		7.5	7.5*	7.5	7.5	15	T	T	T	T	T	T	T	T	T	T	T	
	8		7.5	7.5*	7.5	7.5	15	T	T	T	T	T	T	T	T	T	T	T	
	10		5	5*	5	6.5	9	T	T	T	T	T	T	T	T	T	T	T	
	16		5*	4.5	6.5	8	T	T	T	T	T	T	T	T	T	T	T		
	20				5	7.5	T	T	T	T	T	T	T	T	T	T	T		
	25				5	7.5	T	T	T	T	T	T	T	T	T	T	T		
	32				5**	7.5	T	T	T	T	T	T	T	T	T	T	T		
40					6.5	T	T	T	T	T	T	T	T	T	T	T			
50					5*	T	T	T	T	T	T	T	T	T	T	T			
63						T*	T	T	T	T	T	T	T	T	T	T			

\* Value valid with supply side magnetic only circuit-breaker  
 \*\* Value valid with supply side magnetic only MA 52 circuit-breaker



## Discrimination

Supply side circuit-breaker: MCCB

Load side circuit-breaker: MCB

### Tmax T4 - S290 @ 400/415 V

Load s.	Char.	I <sub>cu</sub> [kA]	Supply s.	T4					
			Version	N, S, H, L, V					
			Release	TM, M			EL		
			I <sub>u</sub> [A]	250			250		320
			I <sub>n</sub> [A]	160	200	250	160	250	320
S290	C-K	15	80	5	11	T	T	T	T
			100	5*	8	T	12	T	T
	C		125		8*	12		T	T
	D		80	5	11	T	T	T	T
			100		8	T	12	T	T

\* Value valid with supply side magnetic only circuit-breaker





## Discrimination

Supply side circuit-breaker: MCCB

Load side circuit-breaker: MCB

**Tmax T4 - S500 @ 400/415 V**

Load s.	Char.	I <sub>cu</sub> [kA]	Supply s.	T4													
			Version	N, S, H, L, V													
			Release	TM, M										EL			
			I <sub>n</sub> [A]	250										250		320	
I <sub>n</sub> [A]	20	25	32	50	80	100	125	160	200	250	100	160	250	320			
S500	B-C	50	6	7.5	7.5*	7.5	7.5	16	T	T	T	T	T	T	T	T	
			10	6.5	6.5*	6.5	6.5	11	T	T	T	T	T	T	T	T	
			13	6.5	5*	6.5	6.5	11	T	T	T	T	T	T	T	T	
			16		5*	6.5	6.5	11	T	T	T	T	T	T	T	T	
			20		4*	6.5	6.5	11	T	T	T	T	T	T	T	T	
			25				6.5	11	T	T	T	T	T	T	T	T	
			32				6.5	8	T	T	T	T	T	T	T	T	
			40				5*	6.5	T	T	T	T	T	T	T	T	
			50					5*	7.5	T	T	T	T	T	T	T	
			63						5*	7	T	T	T	T	T	T	
	D	50	6	7.5	7.5*	7.5	7.5	16	T	T	T	T	T	T	T		
			10	6.5	6.5*	6.5	6.5	11	T	T	T	T	T	T	T		
			13		5*		6.5	11	T	T	T	T	T	T	T		
			16				6.5	11	T	T	T	T	T	T	T		
			20				6.5*	11	T	T	T	T	T	T	T		
			25				6.5*	11	T	T	T	T	T	T	T		
			32					8*	T	T	T	T	T	T	T		
			40					6.5*	T*	T	T	T	T	T	T		
			50						7.5*	T*	T	T	T	T	T		
			63							7*	T*	T	T	T	T		
	K	50	≤5.8	40**	40**	40**	40**	40**	T	T	T	T	T	T	T		
			5.3..8	6	6*	6	6	40**	T	T	T	T	T	T			
			7.3..11		5*	5	5	40**	T	T	T	T	T	T			
			10..15		5*		5	12	T	T	T	T	T	T			
			14..20				5	12	T	T	T	T	T	T			
		30	18..26				5*	12*	T	T	T	T	T	T			
			23..32				5*	12*	T*	T	T	T	T	T			
			29..37				5*	8*	T*	T*	T	T	T	T			
			34..41					6*	T*	T*	T	T	T	T			
			38..45					6*	8*	T*	T*	T	T	T			

\* Value valid with supply side magnetic only circuit-breaker (with I<sub>n</sub> = 50 A please refer to MA52 circuit-breakers)  
 \*\* Select the lowest value between what is indicated and the breaking capacity of the supply side circuit-breaker



# Discrimination

Supply side circuit-breaker: MCCB

Load side circuit-breaker: MCCB

## MCCB - Tmax T1 @ 400/415 V

Load s.	Version	Release	I <sub>u</sub> [A]	Supply s.	T2						T3			T4							
				T1	N,S,H,L						N,S			N,S,H,L,V							
				B, C, N	TM	TM,M	EL				TM,M			TM,M							
				160	160						250			250							
I <sub>n</sub> [A]	160	160	25	63	100	160	160	200	250	20	25	32	50	80	100	125	160	200	250		
T1	B	TM	16	3	3		3	3	3	3	4	5			10**	10	10	10	10	10	10
			20	3	3		3	3	3	3	4	5			10**	10	10	10	10	10	10
			25	3	3		3	3	3	3	4	5			10**	10	10	10	10	10	10
			32	3	3			3	3	3	4	5				10*	10	10	10	10	10
			40	3	3			3	3	3	4	5				10*	10	10	10	10	10
			50	3	3			3	3	3	4	5					10*	10	10	10	10
			63	3	3				3	3	4	5						10*	10	10	10
			80						3		4	5							10	10	10
			100								5								10*	10	10
			125																	10*	10
	160																				
	C	TM	160	25	3	3		3	3	3	3	4	5			10**	10	10	10	10	10
				32	3	3			3	3	3	4	5				10*	10	10	10	10
				40	3	3			3	3	3	4	5				10*	10	10	10	10
				50	3	3			3	3	3	4	5					10*	10	10	10
63				3	3				3	3	4	5						10*	10	10	
80									3		4	5							10	10	
100											5								10*	10	
N	TM	160	32	3	3			3	3	3	4	5			10*	10	10	10	10		
			40	3	3			3	3	3	4	5				10*	10	10	10		
			50	3	3			3	3	3	4	5				10*	10	10	10		
			63	3	3				3	3	4	5					10*	10	10		
			80						3		4	5						10	10		
			100								5							10*	10		
			125															10*	10		

\* Value valid with supply side magnetic only circuit-breaker  
 \*\* Value valid with supply side magnetic only MA 52 circuit-breaker





	T4				T5						T6					S7			
	N,S,H,L,V				N,S,H,L,V						N,S,H,L					S,H,L			
	EL				TM			EL			TM,M		EL			EL			
	250		320		400		630		400		630		630	800	630	800	1000	1250	1600
	100	160	250	320	320	400	500	320	400	630	630	800	630	800	1000	1000	1250	1600	
	10	10	10	10	T	T	T	T	T	T	T	T	T	T	T	T	T	T	T
	10	10	10	10	T	T	T	T	T	T	T	T	T	T	T	T	T	T	T
	10	10	10	10	T	T	T	T	T	T	T	T	T	T	T	T	T	T	T
	10	10	10	10	T	T	T	T	T	T	T	T	T	T	T	T	T	T	T
	10	10	10	10	T	T	T	T	T	T	T	T	T	T	T	T	T	T	T
	10	10	10	10	T	T	T	T	T	T	T	T	T	T	T	T	T	T	T
	10	10	10	10	T	T	T	T	T	T	T	T	T	T	T	T	T	T	T
		10	10	10	T	T	T	T	T	T	T	T	T	T	T	T	T	T	T
		10	10	10	T	T	T	T	T	T	T	T	T	T	T	T	T	T	T
			10	10	T	T	T	T	T	T	T	T	T	T	T	T	T	T	T
			10	10	T	T	T	T	T	T	T	T	T	T	T	T	T	T	T
	10	10	10	10	T	T	T	T	T	T	T	T	T	T	T	T	T	T	T
	10	10	10	10	T	T	T	T	T	T	T	T	T	T	T	T	T	T	T
	10	10	10	10	T	T	T	T	T	T	T	T	T	T	T	T	T	T	T
	10	10	10	10	T	T	T	T	T	T	T	T	T	T	T	T	T	T	T
		10	10	10	T	T	T	T	T	T	T	T	T	T	T	T	T	T	T
		10	10	10	T	T	T	T	T	T	T	T	T	T	T	T	T	T	T
			10	10	T	T	T	T	T	T	T	T	T	T	T	T	T	T	T
			10	10	T	T	T	T	T	T	T	T	T	T	T	T	T	T	T

# Discrimination

Supply side circuit-breaker: MCCB

Load side circuit-breaker: MCCB

## MCCB - Tmax T2 @ 400/415 V

Load s.	Version	Release	I <sub>n</sub> [A]	Supply s.	T2					T3			T4													
				T1	N,S,H,L					N,S			N,S,H,L,V													
				B, C, N	TM	TM,M	EL			TM,M			TM,M													
I <sub>u</sub> [A]	160	160					250			250																
			I <sub>n</sub> [A]	160	160	25	63	100	160	160	200	250	20	25	32	50	80	100	125	160	200	250				
T2	N	TM	160	1.6-2.5	T	T	T	T	T	T	T	T	T	T	T*	T	T	T	T	T	T	T	T			
				3.2	T	T	T	T	T	T	T	T	T	T	T	T	T*	T	T	T	T	T	T	T	T	
				4-5	T	T	T	T	T	T	T	T	T	T	T	T	T*	T	T	T	T	T	T	T	T	T
				6.3	10	10	10	10	10	10	10	10	15	40**	T	T*	T	T	T	T	T	T	T	T	T	T
				8	10	10	10	10	10	10	10	10	15	40**		T*	T	T	T	T	T	T	T	T	T	T
				10	10	10	10	10	10	10	10	10	15	40**		T*	T	T	T	T	T	T	T	T	T	T
				12.5	3	3		3	3	3	3	3	4	5				T	T	T	T	T	T	T	T	T
				16	3	3		3	3	3	3	3	4	5						T	T	T	T	T	T	T
				20	3	3		3	3	3	3	3	4	5						T*	T	T	T	T	T	T
				25	3	3		3	3	3	3	3	4	5						T*	T	T	T	T	T	T
				32	3	3		3	3	3	3	3	4	5						T*	T	T	T	T	T	T
				40	3	3		3	3	3	3	3	4	5						30*	30*	30	30	30	30	30
				50	3	3		3	3	3	3	3	4	5						30*	30*	30	30	30	30	30
				63	3	3		3	3	3	3	3	4	5						30*	30*	30*	30	30	30	30
				80				3	3*	4	5										25*	25*	25*	25	25	25
				100									4*	5								25*	25*	25*	25	25
				125																			25*	25*		
				160																				25*		
						EL	160							3	4				25	25	25	25	25	25	25	25
														3	4					25	25	25	25	25	25	25
										3	4								25	25	25	25				
										3	4											25				
										3	4															

\* Value valid with supply side magnetic only circuit-breaker  
 \*\* Select the lowest value between what is indicated and the breaking capacity of the supply side circuit-breaker

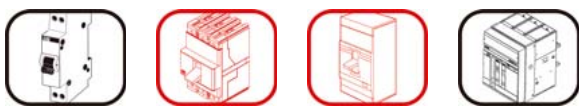



	T4				T5						T6					S7			
	N,S,H,L,V				N,S,H,L,V						N,S,H,L					S,H,L			
	EL				TM			EL			TM,M		EL			EL			
	250		320		400		630		400		630		630	800	630	800	1000	1250	1600
	100	160	250	320	320	400	500	320	400	630	630	800	630	800	1000	1000	1250	1600	
	T	T	T	T	T	T	T	T	T	T	T	T	T	T	T	T	T	T	T
	T	T	T	T	T	T	T	T	T	T	T	T	T	T	T	T	T	T	T
	T	T	T	T	T	T	T	T	T	T	T	T	T	T	T	T	T	T	T
	T	T	T	T	T	T	T	T	T	T	T	T	T	T	T	T	T	T	T
	T	T	T	T	T	T	T	T	T	T	T	T	T	T	T	T	T	T	T
	T	T	T	T	T	T	T	T	T	T	T	T	T	T	T	T	T	T	T
	T	T	T	T	T	T	T	T	T	T	T	T	T	T	T	T	T	T	T
	T	T	T	T	T	T	T	T	T	T	T	T	T	T	T	T	T	T	T
	T	T	T	T	T	T	T	T	T	T	T	T	T	T	T	T	T	T	T
	T	T	T	T	T	T	T	T	T	T	T	T	T	T	T	T	T	T	T
	30	30	30	30	T	T	T	T	T	T	T	T	T	T	T	T	T	T	T
	30	30	30	30	T	T	T	T	T	T	T	T	T	T	T	T	T	T	T
	30	30	30	30	T	T	T	T	T	T	T	T	T	T	T	T	T	T	T
		25	25	25	T	T	T	T	T	T	T	T	T	T	T	T	T	T	T
		25	25	25	T	T	T	T	T	T	T	T	T	T	T	T	T	T	T
			25	25	T	T	T	T	T	T	T	T	T	T	T	T	T	T	T
			25	25	T	T	T	T	T	T	T	T	T	T	T	T	T	T	T
	25	25	25	25	T	T	T	T	T	T	T	T	T	T	T	T	T	T	T
	25	25	25	25	T	T	T	T	T	T	T	T	T	T	T	T	T	T	T
	25	25	25	25	T	T	T	T	T	T	T	T	T	T	T	T	T	T	T
		25	25	25	T	T	T	T	T	T	T	T	T	T	T	T	T	T	T
			25	25	T	T	T	T	T	T	T	T	T	T	T	T	T	T	T

# Discrimination

Supply side circuit-breaker: MCCB

Load side circuit-breaker: MCCB

## MCCB - Tmax T2 @ 400/415 V

Load s.	Version	Release	I <sub>n</sub> [A]	Supply s.	T2					T3			T4											
				T1	N,S,H,L					N,S			N,S,H,L,V											
				B, C, N	TM	TM,M	EL			TM,M			TM,M											
				160	160					250			250											
I <sub>u</sub> [A]	160	160	25	63	100	160	160	200	250	20	25	32	50	80	100	125	160	200	250					
T2	S	TM	160	1.6-2.5	T	T	T	T	T	T	T	T	T	T	T	T	T	T	T	T	T			
				3.2	T	T	T	T	T	T	T	T	T	T*	T	T	T	T	T	T	T	T		
				4-5	T	T	T	T	T	T	T	T	T	T	T*	T	T	T	T	T	T	T	T	
				6.3	10	10	10	10	10	10	10	15	40**	T	T*	T	T	T	T	T	T	T	T	
				8	10	10	10	10	10	10	10	15	40**		T*	T	T	T	T	T	T	T	T	
				10	10	10	10	10	10	10	10	15	40**		T*	T	T	T	T	T	T	T	T	
				12.5	3	3		3	3	3	3	4	5			T	T	T	T	T	T	T	T	
				16	3	3		3	3	3	3	4	5					T	T	T	T	T	T	
				20	3	3		3	3	3	3	4	5					T*	T	T	T	T	T	
				25	3	3		3	3	3	3	4	5					40***	40**	40**	40**	40**	40**	
				32	3	3		3	3	3	3	4	5					40***	40**	40**	40**	40**	40**	
				40	3	3		3	3	3	3	4	5					30*	30*	30	30	30	30	
				50	3	3		3	3	3	3	4	5					30*	30*	30	30	30	30	
				63	3	3				3	3	4	5					30*	30*	30*	30	30	30	
				80						3	3*	4	5						25*	25*	25*	25	25	
				100								4	5							25*	25*	25*	25	
				125																	25*	25*		
				160																		25*		
						EL	160	10						3	4				25	25	25	25	25	25
					25									3	4				25	25	25	25	25	25
	63									3	4								25	25	25			
	100									3	4										25			
	160									3	4													

\* Value valid with supply side magnetic only circuit-breaker

\*\* Select the lowest value between what is indicated and the breaking capacity of the supply side circuit-breaker





	T4				T5						T6					S7			
	N,S,H,L,V				N,S,H,L,V						N,S,H,L					S,H,L			
	EL				TM			EL			TM,M		EL			EL			
	250		320		400		630		400		630		630	800	630	800	1000	1250	1600
	100	160	250	320	320	400	500	320	400	630	630	800	630	800	1000	1000	1250	1600	
	T	T	T	T	T	T	T	T	T	T	T	T	T	T	T	T	T	T	T
	T	T	T	T	T	T	T	T	T	T	T	T	T	T	T	T	T	T	T
	T	T	T	T	T	T	T	T	T	T	T	T	T	T	T	T	T	T	T
	T	T	T	T	T	T	T	T	T	T	T	T	T	T	T	T	T	T	T
	T	T	T	T	T	T	T	T	T	T	T	T	T	T	T	T	T	T	T
	T	T	T	T	T	T	T	T	T	T	T	T	T	T	T	T	T	T	T
	T	T	T	T	T	T	T	T	T	T	T	T	T	T	T	T	T	T	T
	T	T	T	T	T	T	T	T	T	T	T	T	T	T	T	T	T	T	T
	T	T	T	T	T	T	T	T	T	T	T	T	T	T	T	T	T	T	T
	40**	40**	40**	40**	T	T	T	T	T	T	T	T	T	T	T	T	T	T	T
	40**	40**	40**	40**	T	T	T	T	T	T	T	T	T	T	T	T	T	T	T
	30	30	30	30	T	T	T	T	T	T	T	T	T	T	T	T	T	T	T
	30	30	30	30	T	T	T	T	T	T	T	T	T	T	T	T	T	T	T
	30	30	30	30	T	T	T	T	T	T	T	T	T	T	T	T	T	T	T
		25	25	25	T	T	T	T	T	T	T	T	T	T	T	T	T	T	T
		25	25	25	T	T	T	T	T	T	T	T	T	T	T	T	T	T	T
			25	25	T	T	T	T	T	T	T	T	T	T	T	T	T	T	T
			25	25	T	T	T	T	T	T	T	T	T	T	T	T	T	T	T
	25	25	25	25	T	T	T	T	T	T	T	T	T	T	T	T	T	T	T
	25	25	25	25	T	T	T	T	T	T	T	T	T	T	T	T	T	T	T
	25	25	25	25	T	T	T	T	T	T	T	T	T	T	T	T	T	T	T
		25	25	25	T	T	T	T	T	T	T	T	T	T	T	T	T	T	T
			25	25	T	T	T	T	T	T	T	T	T	T	T	T	T	T	T

# Discrimination

Supply side circuit-breaker: MCCB

Load side circuit-breaker: MCCB

## MCCB - Tmax T2 @ 400/415 V

Load s.	Version	Release	I <sub>n</sub> [A]	Supply s.	T2						T3			T4													
				T1	N,S,H,L						N,S			N,S,H,L,V													
				B, C, N	TM	TM,M	EL				TM,M			TM,M													
				160	160						250			250													
			I <sub>n</sub> [A]	160	160	25	63	100	160	160	200	250	20	25	32	50	80	100	125	160	200	250					
T2	H	TM	160	1.6-2.5	T	T	T	T	T	T	T	T	T	T	T*	T	T	T	T	T	T	T	T	T			
				3.2	T	T	T	T	T	T	T	T	T	T	T	T	T*	T	T	T	T	T	T	T	T	T	
				4-5	T	T	T	T	T	T	T	T	T	T	T	T	T	T*	T	T	T	T	T	T	T	T	T
				6.3	10	10	10	10	10	10	10	10	15	40**	T	T*	T	T	T	T	T	T	T	T	T	T	T
				8	10	10	10	10	10	10	10	10	15	40**		T*	T	T	T	T	T	T	T	T	T	T	T
				10	10	10	10	10	10	10	10	10	15	40**		T*	T	T	T	T	T	T	T	T	T	T	T
				12.5	3	3		3	3	3	3	3	4	5				T	T	T	T	T	T	T	T	T	T
				16	3	3		3	3	3	3	3	4	5					T	T	T	T	T	T	T	T	T
				20	3	3		3	3	3	3	3	4	5						55***	55**	55**	55**	55**	55**	55**	55**
				25	3	3		3	3	3	3	3	4	5						40***	40**	40**	40**	40**	40**	40**	40**
				32	3	3		3	3	3	3	3	4	5						40***	40**	40**	40**	40**	40**	40**	40**
				40	3	3		3	3	3	3	3	4	5						30*	30*	30	30	30	30	30	30
				50	3	3		3	3	3	3	3	4	5						30*	30*	30	30	30	30	30	30
				63	3	3		3	3	3	3	3	4	5						30*	30*	30*	30	30	30	30	30
				80				3	3*	4	5										25*	25*	25*	25	25	25	25
				100						4	5											25*	25*	25*	25	25	25
				125																			25*	25*			
				160																				25*			
						EL	160	10						3	4					25	25	25	25	25	25	25	25
					25									3	4						25	25	25	25	25	25	25
	63									3	4										25	25	25	25			
	100									3	4													25			
	160									3	4														25		

\* Value valid with supply side magnetic only circuit-breaker

\*\* Select the lowest value between what is indicated and the breaking capacity of the supply side circuit-breaker

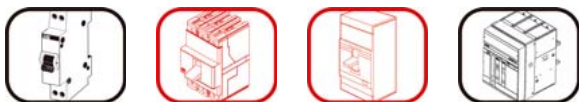





	T4				T5						T6					S7			
	N,S,H,L,V				N,S,H,L,V						N,S,H,L					S,H,L			
	EL				TM			EL			TM,M		EL			EL			
	250		320		400		630		400		630		630	800	630	800	1000	1250	1600
	100	160	250	320	320	400	500	320	400	630	630	800	630	800	1000	1000	1250	1600	
	T	T	T	T	T	T	T	T	T	T	T	T	T	T	T	T	T	T	T
	T	T	T	T	T	T	T	T	T	T	T	T	T	T	T	T	T	T	T
	T	T	T	T	T	T	T	T	T	T	T	T	T	T	T	T	T	T	T
	T	T	T	T	T	T	T	T	T	T	T	T	T	T	T	T	T	T	T
	T	T	T	T	T	T	T	T	T	T	T	T	T	T	T	T	T	T	T
	T	T	T	T	T	T	T	T	T	T	T	T	T	T	T	T	T	T	T
	T	T	T	T	T	T	T	T	T	T	T	T	T	T	T	T	T	T	T
	T	T	T	T	T	T	T	T	T	T	T	T	T	T	T	T	T	T	T
	55**	55**	55**	55**	T	T	T	T	T	T	T	T	T	T	T	T	T	T	T
	40**	40**	40**	40**	T	T	T	T	T	T	T	T	T	T	T	T	T	T	T
	40**	40**	40**	40**	T	T	T	T	T	T	T	T	T	T	T	T	T	T	T
	30	30	30	30	T	T	T	T	T	T	T	T	T	T	T	T	T	T	T
	30	30	30	30	T	T	T	T	T	T	T	T	T	T	T	T	T	T	T
	30	30	30	30	T	T	T	T	T	T	T	T	T	T	T	T	T	T	T
		25	25	25	T	T	T	T	T	T	T	T	T	T	T	T	T	T	T
		25	25	25	T	T	T	T	T	T	T	T	T	T	T	T	T	T	T
			25	25	T	T	T	T	T	T	T	T	T	T	T	T	T	T	T
			25	25	T	T	T	T	T	T	T	T	T	T	T	T	T	T	T
	25	25	25	25	T	T	T	T	T	T	T	T	T	T	T	T	T	T	T
	25	25	25	25	T	T	T	T	T	T	T	T	T	T	T	T	T	T	T
	25	25	25	25	T	T	T	T	T	T	T	T	T	T	T	T	T	T	T
		25	25	25	T	T	T	T	T	T	T	T	T	T	T	T	T	T	T
			25	25	T	T	T	T	T	T	T	T	T	T	T	T	T	T	T

# Discrimination

Supply side circuit-breaker: MCCB

Load side circuit-breaker: MCCB

## MCCB - Tmax T2 @ 400/415 V

Load s.	Version	Release	I <sub>n</sub> [A]	Supply s.	T1	T2					T3			T4												
				I <sub>u</sub> [A]	B, C, N	N,S,H,L					N,S			N,S,H,L,V												
					TM	TM,M	EL					TM,M			TM,M											
					160	160					250			250												
			160	160	25	63	100	160	160	200	250	20	25	32	50	80	100	125	160	200	250					
T2	L	TM	160	1.6-2.5	T	T	T	T	T	T	T	T	T	T*	T	T	T	T	T	T	T	T	T			
				3.2	T	T	T	T	T	T	T	T	T	T	T	T*	T	T	T	T	T	T	T	T	T	
				4-5	T	T	T	T	T	T	T	T	T	T	T	T	T*	T	T	T	T	T	T	T	T	T
				6.3	10	10	10	10	10	10	10	10	15	40**	T	T*	T	T	T	T	T	T	T	T	T	T
				8	10	10	10	10	10	10	10	10	15	40**		T*	T	T	T	T	T	T	T	T	T	T
				10	10	10	10	10	10	10	10	10	15	40**		T*	T	T	T	T	T	T	T	T	T	T
				12.5	3	3		3	3	3	3	3	4	5			T	T	T	T	T	T	T	T	T	T
				16	3	3		3	3	3	3	3	4	5					70**	70**	70**	70**	70**	70**	70**	70**
				20	3	3		3	3	3	3	3	4	5					55**	55**	55**	55**	55**	55**	55**	55**
				25	3	3		3	3	3	3	3	4	5					40**	40**	40**	40**	40**	40**	40**	40**
				32	3	3		3	3	3	3	3	4	5					40**	40**	40**	40**	40**	40**	40**	40**
				40	3	3		3	3	3	3	3	4	5					30*	30*	30	30	30	30	30	30
				50	3	3		3	3	3	3	3	4	5					30*	30*	30	30	30	30	30	30
				63	3	3		3	3	3	3	3	4	5					30*	30*	30*	30	30	30	30	30
				80				3	3*	4	5									25*	25*	25*	25	25	25	25
				100						4	5										25*	25*	25*	25	25	25
				125																		25*	25*			
				160																			25*			
						EL	160	10						3	4				25	25	25	25	25	25	25	25
				25										3	4					25	25	25	25	25	25	25
63											3	4								25	25	25	25			
100											3	4											25			
160											3	4												25		

\* Value valid with supply side magnetic only circuit-breaker

\*\* Select the lowest value between what is indicated and the breaking capacity of the supply side circuit-breaker





	T4				T5						T6					S7			
	N,S,H,L,V				N,S,H,L,V						N,S,H,L					S,H,L			
	EL				TM			EL			TM,M		EL			EL			
	250		320		400		630		400		630		630	800	630	800	1000	1250	1600
	100	160	250	320	320	400	500	320	400	630	630	800	630	800	1000	1000	1250	1600	
	T	T	T	T	T	T	T	T	T	T	T	T	T	T	T	T	T	T	T
	T	T	T	T	T	T	T	T	T	T	T	T	T	T	T	T	T	T	T
	T	T	T	T	T	T	T	T	T	T	T	T	T	T	T	T	T	T	T
	T	T	T	T	T	T	T	T	T	T	T	T	T	T	T	T	T	T	T
	T	T	T	T	T	T	T	T	T	T	T	T	T	T	T	T	T	T	T
	T	T	T	T	T	T	T	T	T	T	T	T	T	T	T	T	T	T	T
	T	T	T	T	T	T	T	T	T	T	T	T	T	T	T	T	T	T	T
	70**	70**	70**	70**	T	T	T	T	T	T	T	T	T	T	T	T	T	T	T
	55**	55**	55**	55**	T	T	T	T	T	T	T	T	T	T	T	T	T	T	T
	40**	40**	40**	40**	T	T	T	T	T	T	T	T	T	T	T	T	T	T	T
	40**	40**	40**	40**	T	T	T	T	T	T	T	T	T	T	T	T	T	T	T
	30	30	30	30	T	T	T	T	T	T	T	T	T	T	T	T	T	T	T
	30	30	30	30	T	T	T	T	T	T	T	T	T	T	T	T	T	T	T
	30	30	30	30	T	T	T	T	T	T	T	T	T	T	T	T	T	T	T
		25	25	25	T	T	T	T	T	T	T	T	T	T	T	T	T	T	T
		25	25	25	T	T	T	T	T	T	T	T	T	T	T	T	T	T	T
			25	25	T	T	T	T	T	T	T	T	T	T	T	T	T	T	T
			25	25	T	T	T	T	T	T	T	T	T	T	T	T	T	T	T
	25	25	25	25	T	T	T	T	T	T	T	T	T	T	T	T	T	T	T
	25	25	25	25	T	T	T	T	T	T	T	T	T	T	T	T	T	T	T
	25	25	25	25	T	T	T	T	T	T	T	T	T	T	T	T	T	T	T
		25	25	25	T	T	T	T	T	T	T	T	T	T	T	T	T	T	T
			25	25	T	T	T	T	T	T	T	T	T	T	T	T	T	T	T

# Discrimination

Supply side circuit-breaker: MCCB

Load side circuit-breaker: MCCB

## MCCB - Tmax T3 @ 400/415 V

		Supply s.		T1					T2					T3			T4									
Version				B, C, N					N,S,H,L					N,S			N,S,H,L,V									
Release				TM					TM,M					TM,M			TM,M									
I <sub>u</sub> [A]		160		160					250			250														
Load s.		I <sub>n</sub> [A]	160	160	25	63	100	160	160	200	250	20	25	32	50	80	100	125	160	200	250					
T3	N	TM	250	63						3	4	5							7*	7	7	7				
				80							3*	4	5								7*	7	7			
				100								4*	5									7*	7*	7		
				125																			7*			
				160																						
				200																						
				250																						
	S	TM	250	63						3	4	5								7*	7	7	7			
				80							3*	4	5								7*	7	7			
				100								4*	5								7*	7*	7			
				125																		7*				
				160																						
				200																						
				250																						

\* Value valid with supply side magnetic only circuit-breaker

\*\* Select the lowest value between what is indicated and the breaking capacity of the supply side circuit-breaker

## MCCB - Tmax T4 @ 400/415 V

		Supply s.		T5						T6				S7								
Version				N,S,H,L,V						N,S,H,L				S,H,L								
Release				TM			EL			TM,M		EL		EL								
I <sub>u</sub> [A]		400		630			400			630			630		800		1000		1250		1600	
Load s.		I <sub>n</sub> [A]	320	400	500	320	400	630	630	800	630	800	1000	1000	1250	1600						
T4	N, S, H, L, V	TM	250	20	T	T	T	T	T	T	T	T	T	T	T	T						
				32	T	T	T	T	T	T	T	T	T	T	T	T						
				50	T	T	T	T	T	T	T	T	T	T	T	T	T					
				80	T	T	T	T	T	T	T	T	T	T	T	T	T					
				100		50*	50*	50*	50*	50*	T	T	T	T	T	T	T					
				125			50*	50*	50*	50*	T	T	T	T	T	T	T					
				160				50*	50*	50*	T	T	T	T	T	T	T					
				200				50*	50*	50*	T	T	T	T	T	T	T					
		250					50*	50*	T	T	T	T	T	T	T							
		EL	250	100	50*	50*	50*	50*	50*	50*	T	T	T	T	T	T	T					
				160	50*	50*	50*	50*	50*	50*	T	T	T	T	T	T						
				250			50*		50*	50*	T	T	T	T	T	T						
				320					50*	T	T	T	T	T	T							
				320						50*	T	T	T	T	T							
320									50*	T	T	T	T									

\* Select the lowest value among what is indicated, the breaking capacity of the supply side circuit-breaker and the breaking capacity of the load side circuit-breaker





	T4				T5						T6					S7						
	N,S,H,L,V				N,S,H,L,V						N,S,H,L					S,H,L						
	EL				TM			EL			TM,M		EL			EL						
	250		320		400		630		400		630		630		800		1000		1250		1600	
	100	160	250	320	320	400	500	320	400	630	630	800	630	800	1000	1000	1250	1600				
	7	7	7	7	25	25	25	25	25	25	T	T	T	T	T	T	T	T	T	T	T	
		7	7	7	25	25	25	25	25	25	T	T	T	T	T	T	T	T	T	T	T	T
			7	7	25	25	25	25	25	25	T	T	T	T	T	T	T	T	T	T	T	T
				7	20	20	20	20	20	20	T	T	T	T	T	T	T	T	T	T	T	T
							20	20	20	20	T	T	T	T	T	T	T	T	T	T	T	T
								20	20	20	30	T	30	T	T	T	T	T	T	T	T	T
									20	20	30	T	30	T	T	T	T	T	T	T	T	T
	7	7	7	7	25	25	25	25	25	25	T	T	T	T	T	T	T	T	T	T	T	T
		7	7	7	25	25	25	25	25	25	T	T	T	T	T	T	T	T	T	T	T	T
			7	7	25	25	25	25	25	25	40**	T	40**	T	T	T	T	T	T	T	T	T
				7	20	20	20	20	20	20	36	T	36	T	T	T	T	T	T	T	T	T
							20	20	20	20	36	T	36	T	T	T	T	T	T	T	T	T
								20	20	20	30	T	30	T	T	T	T	T	T	T	T	T
									20	20	30	40**	30	40**	40**	T	T	T	T	T	T	T

## Discrimination

Supply side circuit-breaker: MCCB

Load side circuit-breaker: MCCB

### MCCB - Tmax T5 @ 400/415 V

		Supply s.		T6					S7			
Version				N,S,H,L					S,H,L			
		Release		TM,M		EL			EL			
		I <sub>u</sub> [A]		630	800	630	800	1000	1250	1600		
Load s.		I <sub>n</sub> [A]		630	800	630	800	1000	1000	1250	1600	
T5	N, S, H, L, V	TM	400	320	30	30	30	30	30	T	T	T
			400	400		30		30	30	T	T	T
			630	500				30	30	T	T	T
		EL	400	320	30	30	30	30	30	T	T	T
			400	400	30	30	30	30	30	T	T	T
			630	630					30	T	T	T

### MCCB - Tmax T6 @ 400/415 V

		Supply s.		S7			
Version				S,H,L			
		Release		EL			
		I <sub>u</sub> [A]		1250	1600		
Load s.		I <sub>n</sub> [A]		1000	1250	1600	
T6	N	TM	630	630		T	T
			800	800		T	T
		EL	630	630	T	T	T
			800	800	T	T	T
			1000	1000		T	T
		S	TM	630	630		40
	800			800		40	40
	EL		630	630	40	40	40
			800	800	40	40	40
			1000	1000		40	40
	H		TM	630	630		40
		800		800		40	40
		EL	630	630	40	40	40
			800	800	40	40	40
			1000	1000		40	40
		L	TM	630	630		40
	800			800		40	40
	EL		630	630	40	40	40
800			800	40	40	40	
1000			1000		40	40	



# Discrimination

Supply side circuit-breaker: ACB

Load side circuit-breaker: MCCB

## ACB - MCCB @ 400/415 V

Load s.	Version	Release	Supply s. I <sub>n</sub> [A]	E1		E2				E3					E4			E6		
				B	N	B	N	S	L*	N	S	H	V	L*	S	H	V	H	V	
				EL		EL				EL					EL			EL		
T1	B	TM	160	800	800	1600	1000	800	1250	2500	1000	800	800	2000	4000	3200	3200	4000	3200	
	C			1000	1000	2000	1250	1000	1600	1250	1000	1000	1000	4000	4000	4000	5000	4000		
	N			1250	1250		1600	1250	1600	1250	1600	1600	1600							
				1600	1600		2000	1600	2000	2000	2500	2000	2000	2500						
T2	N	TM,EL	160	T	T	T	T	T	T	T	T	T	T	T	T	T	T	T		
	S			T	T	T	T	T	T	T	T	T	T	T	T	T	T	T		
	H			T	T	T	55	65	T	T	T	T	T	T	T	T	T	T	T	
	L			T	T	T	55	65	T	T	T	75	T	T	T	T	T	T	T	
T3	N	TM	250	T	T	T	T	T	T	T	T	T	T	T	T	T	T	T		
	S			T	T	T	T	T	T	T	T	T	T	T	T	T	T	T		
T4	N	TM,EL	250	T	T	T	T	T	T	T	T	T	T	T	T	T	T	T		
	S			T	T	T	T	T	T	T	T	T	T	T	T	T	T	T		
	H			T	T	T	55	65	T	T	T	T	T	T	T	T	T	T		
	L			T	T	T	55	65	100	T	T	75	85	100	T	T	100	T	100	
T5	N	TM,EL	400	T	T	T	T	T	T	T	T	T	T	T	T	T	T	T		
	S			T	T	T	T	T	T	T	T	T	T	T	T	T	T	T		
	H			T	T	T	55	65	T	T	T	T	T	T	T	T	T	T		
	L			T	T	T	55	65	100	T	T	75	85	100	T	T	100	T	100	
T6	N	TM,EL	630	T	T	T	T	T	T	T	T	T	T	T	T	T	T	T		
	S			T	T	T	T	T	T	T	T	T	T	T	T	T	T			
	H			T	T	T	55	65	T	T	T	T	T	T	T	T	T			
	L			T	T	T	55	65	T	T	T	75	85	T	T	T	T			
S7	S	EL	1250	T	T	T	T	T	T	T	T	T	T	T	T	T	T	T		
	H			T	T	T	55	T	T	T	T	T	T	T	T	T				
	L			T	T	T	55	65	T	T	T	75	85	T	T	T				

Table valid for Emax circuit-breakers only with PR121/P, PR122/P and PR123/P releases

\* Emax L circuit-breakers only with PR122/P and PR123/P releases

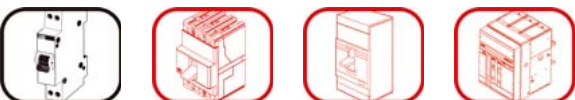

2

---

# Coordination tables

## Motor protection

---

Notes for use .....	3/2
DOL Type 2 - Normal starting	
415 V - 35 kA .....	3/4
415 V - 50 kA .....	3/5
415 V - 70 kA .....	3/6
415 V - 80 kA .....	3/7
440 V - 50 kA .....	3/8
440 V - 65 kA .....	3/9
500 V - 50 kA .....	3/10
690 V - 50 kA .....	3/11
DOL Type 2 - Heavy duty	
415 V - 35 kA .....	3/12
415 V - 50 kA .....	3/13
440 V - 50 kA .....	3/14
440 V - 65 kA .....	3/15
500 V - 50 kA .....	3/16
690 V - 50 kA .....	3/17
Star-delta - Type 2	
415 V - 35 kA .....	3/18
415 V - 50 kA .....	3/18
440 V - 50 kA .....	3/19
440 V - 65 kA .....	3/19
500 V - 50 kA .....	3/20
690 V - 50 kA .....	3/20
DOL Type 2 - Start-up with MP release	
415 V - 35 kA .....	3/21
415 V - 50 kA .....	3/21
440 V - 50 kA .....	3/22
500 V - 50 kA .....	3/22
690 V - 50 kA .....	3/23



---

# Motor protection

## Notes for use

---

ABB SACE proposes a vast range of coordination solutions for the power supply of any motor for which protection against short-circuit and overload are of fundamental importance.

### Standard used

- IEC 60947 - 4 – 1

### Rated power of the motor

- The tables are based on the current consumed by electric, three-phase squirrel cage ABB induction motors with four poles.
- The rated power of the motor is expressed in kiloWatt

### Protection device

As protection device, the following tables use the moulded-case circuit-breakers (**MCCB**) with the following types of releases:

- MF fixed magnetic only release (for Tmax T2 circuit-breakers)
- MA magnetic only release adjustable (for Tmax T2e T3 circuit-breakers)
- PR221/I electronic release (for Tmax T4 and T5 circuit-breakers)
- PR222MP electronic release (for Tmax T4 and T5 circuit-breakers).

The solutions proposed refer to an ambient temperature of 40 °C and to fixed version apparatus. For higher temperatures, please contact ABB SACE.

### Type of starting

- By **normal** starting, a starting time up to 2 s is intended in accordance with the trip time of the thermal relays in class 10 A (see table 2).
- By **heavy** duty, a starting time up to 9 s is intended in accordance with the trip time of the thermal relays in class 30 (see table 2).
- Two factors must be considered for **normal star-delta** starting: the speed the motor has reached at the end of the starting period is 85% higher than the rated one; the transition time between the star delta connection is 80 ms shorter.

### Short-circuit current

- The valid selection for a certain value also covers lower levels of short-circuit. For example, by selecting 80 kA, protection which is also valid for lower values is obtained (70, 60..kA, at the same voltage). This means a starter with higher performances at the required breaking capacity. For more economical solutions, verifying some specific solutions for lower short-circuit levels is recommended.

# Motor protection

## Notes for use

### Notes

To determine a type of coordination univocally, and therefore the apparatus needed to carry it out, the following must be known:

- motor power in kW and the type;
- rated installation voltage;
- rated current of the motor;
- short-circuit current at the point of installation;
- type of starting: DOL or Y/Δ - Normal or Heavy - Type 1 o Type 2.

### Example for using the tables

You want to realize Y/Δ Normal Type 2 starting of a three-phase asynchronous squirrelcage motor with the following data:

rated voltage	$U_r = 400 \text{ V}$
short-circuit current	$I_k = 50 \text{ kA}$
rated motor power	$P_e = 200 \text{ kW}$

The following information is read from the table (star-delta 400 V 50 kA), in correspondence with the relative line:

$I_e$ (rated current):	349 A
protection device against short-circuit:	T5S630 PR221-I In630 circuit-breaker
magnetic trip threshold:	$I_3 = 4410 \text{ A}$
line contactor:	A210
delta contactor:	A210
star contactor:	A185
thermal relay:	E320DU320 adjustable 105-320 A (to adjusted to $\frac{I_e}{\sqrt{3}} = 202 \text{ A}$ ).

### Caption of symbols



MCB Tmax Isomax Emax

For solutions not shown in these tables, please consult the website:

<http://bol.it.abb.com>

or contact ABB SACE

# Motor protection

## DOL Type 2 - Normal starting

**DOL @ 400/415 V - 35 kA - Type 2 - Normal starting**

Motor		MCCB		Contactor	Thermal release			Group
Rated Power Pe [kW]	Rated current Ie [A]	Type	Setting of the magnetic release [A]	Type	Type	Current setting		I max [A]
						min [A]	max [A]	
0.37	1.1	T2N160 MF1.6	21	A9	TA25DU1.4	1	1.4	1.4
0.55	1.5	T2N160 MF1.6	21	A9	TA25DU1.8	1.3	1.8	1.6
0.75	1.9	T2N160 MF 2	26	A9	TA25DU2.4	1.7	2.4	2
1.1	2.8	T2N160 MF 3.2	42	A9	TA25DU4	2.8	4	3.2
1.5	3.5	T2N160 MF 4	52	A16	TA25DU5	3.5	5	4
2.2	5	T2N160 MF 5	65	A26	TA25DU6.5	4.5	6.5	5
3	6.6	T2N160 MF 8.5	110	A26	TA25DU8.5	6	8.5	8.5
4	8.6	T2N160 MF 11	145	A30	TA25DU11	7.5	11	11
5.5	11.5	T2N160 MF 12.5	163	A30	TA25DU14	10	14	12.5
7.5	15.2	T2N160 MA 20	210	A30	TA25DU19	13	19	19
11	22	T2N160 MA 32	288	A30	TA42DU25	18	25	25
15	28.5	T2N160 MA 52	392	A50	TA75DU42	29	42	42
18.5	36	T2N160 MA 52	469	A50	TA75DU52	36	52	50
22	42	T2N160 MA 52	547	A50	TA75DU52	36	52	50
30	56	T2N160 MA 80	840	A63	TA75DU80	60	80	65
37	68	T2N160 MA 80	960	A75	TA75DU80	60	80	75
45	83	T2N160 MA 100	1200	A95	TA110DU110	80	110	96
55	98	T3N250 MA 160	1440	A110	TA110DU110	80	110	110
75	135	T3N250 MA 200	1800	A145	TA200DU175	130	175	145
90	158	T3N250 MA 200	2400	A185	TA200DU200	150	200	185
110	193	T4N320 PR221-I In320	2720	A210	E320DU320	100	320	210
132	232	T5N400 PR221-I In400	3200	A260	E320DU320	100	320	260
160	282	T5N400 PR221-I In400	4000	A300	E320DU320	100	320	300
200	349	T5N630 PR221-I In630	5040	AF400	E500DU500	150	500	400
250	430	T6N630 PR221-I In630	6300	AF460	E500DU500	150	500	430
290	520	T6N800 PR221-I In800	7200	AF580	E800DU800	250	800	580
315	545	T6N800 PR221-I In800	8000	AF580	E800DU800	250	800	580
355	610	T6N800 PR221-I In800	8000	AF750	E800DU800	250	800	750



# Motor protection

## DOL Type 2 - Normal starting

**DOL @ 400/415 V - 50 kA - Type 2 - Normal starting**

Motor		MCCB		Contactor	Thermal release			Group
Rated Power <b>Pe</b> [kW]	Rated current <b>Ie</b> [A]	Type	Setting of the magnetic release [A]	Type	Type	Current setting		I max [A]
						min [A]	max [A]	
0.37	1.1	T2S160 MF 1.6	21	A9	TA25DU1.4	1	1.4	1.4
0.55	1.5	T2S160 MF 1.6	21	A9	TA25DU1.8	1.3	1.8	1.6
0.75	1.9	T2S160 MF 2	26	A9	TA25DU2.4	1.7	2.4	2
1.1	2.8	T2S160 MF 3.2	42	A9	TA25DU4	2.8	4	3.2
1.5	3.5	T2S160 MF 4	52	A16	TA25DU5	3.5	5	4
2.2	5	T2S160 MF 5	65	A26	TA25DU6.5	4.5	6.5	5
3	6.6	T2S160 MF 8.5	110	A26	TA25DU8.5	6	8.5	8.5
4	8.6	T2S160 MF 11	145	A30	TA25DU11	7.5	11	11
5.5	11.5	T2S160 MF 12.5	163	A30	TA25DU14	10	14	12.5
7.5	15.2	T2S160 MA 20	210	A30	TA25DU19	13	19	19
11	22	T2S160 MA 32	288	A30	TA42DU25	18	25	25
15	28.5	T2S160 MA 52	392	A50	TA75DU42	29	42	42
18.5	36	T2S160 MA 52	469	A50	TA75DU52	36	52	50
22	42	T2S160 MA 52	547	A50	TA75DU52	36	52	50
30	56	T2S160 MA 80	840	A63	TA75DU80	60	80	65
37	68	T2S160 MA 80	960	A75	TA75DU80	60	80	75
45	83	T2S160 MA 100	1200	A95	TA110DU110	80	110	96
55	98	T3S250 MA 160	1440	A110	TA110DU110	80	110	110
75	135	T3S250 MA 200	1800	A145	TA200DU175	130	175	145
90	158	T3S250 MA 200	2400	A185	TA200DU200	150	200	185
110	193	T4S320 PR221-I In320	2720	A210	E320DU320	100	320	210
132	232	T5S400 PR221-I In400	3200	A260	E320DU320	100	320	260
160	282	T5S400 PR221-I In400	4000	A300	E320DU320	100	320	300
200	349	T5S630 PR221-I In630	5040	AF400	E500DU500	150	500	400
250	430	T6S630 PR221-I In630	6300	AF460	E500DU500	150	500	430
290	520	T6S800 PR221-I In800	7200	AF580	E800DU800	250	800	580
315	545	T6S800 PR221-I In800	8000	AF580	E800DU800	250	800	580
355	610	T6S800 PR221-I In800	8000	AF750	E800DU800	250	800	750

3



# Motor protection

## DOL Type 2 - Normal starting

**DOL @ 400/415 V - 70 kA - Type 2 - Normal starting**

Motor		MCCB		Contactor	Thermal release			Group
Rated Power Pe [kW]	Rated current Ie [A]	Type	Setting of the magnetic release [A]	Type	Type	Current setting		I max [A]
						min [A]	max [A]	
0.37	1.1	T2H160 MF 1.6	21	A9	TA25DU1.4	1	1.4	1.4
0.55	1.5	T2H160 MF 1.6	21	A9	TA25DU1.8	1.3	1.8	1.6
0.75	1.9	T2H160 MF 2	26	A9	TA25DU2.4	1.7	2.4	2
1.1	2.8	T2H160 MF 3.2	42	A16	TA25DU4	2.8	4	3.2
1.5	3.5	T2H160 MF 4	52	A26	TA25DU5	3.5	5	4
2.2	5	T2H160 MF 5	65	A26	TA25DU6.5	4.5	6.5	5
3	6.6	T2H160 MF 8.5	110	A26	TA25DU8.5	6	8.5	8.5
4	8.6	T2H160 MF 11	145	A30	TA25DU11	7.5	11	11
5.5	11.5	T2H160 MF 12.5	163	A50	TA25DU14	10	14	12.5
7.5	15.2	T2H160 MA 20	210	A50	TA25DU19	13	19	19
11	22	T2H160 MA 32	288	A50	TA42DU25	18	25	25
15	28.5	T2H160 MA 52	392	A50	TA75DU42	29	42	42
18.5	36	T2H160 MA 52	469	A50	TA75DU52	36	52	50
22	42	T2H160 MA 52	547	A50	TA75DU52	36	52	50
30	56	T2H160 MA 80	840	A63	TA75DU80	60	80	65
37	68	T2H160 MA 80	960	A75	TA75DU80	60	80	75
45	83	T2H160 MA 100	1200	A95	TA110DU110	80	110	96
55	98	T4H250 PR221-I In160	1360	A110	TA110DU110	80	110	110
75	135	T4H250 PR221-I In250	1875	A145	E200DU200	60	200	145
90	158	T4H250 PR221-I In250	2500	A185	E200DU200	60	200	185
110	193	T4H320 PR221-I In320	2720	A210	E320DU320	100	320	210
132	232	T5H400 PR221-I In400	3200	A260	E320DU320	100	320	260
160	282	T5H400 PR221-I In400	4000	A300	E320DU320	100	320	300
200	349	T5H630 PR221-I In630	5040	AF400	E500DU500	150	500	400
250	430	T6H630 PR221-I In630	6300	AF460	E500DU500	150	500	430
290	520	T6H800 PR221-I In800	7200	AF580	E800DU800	250	800	580
315	545	T6H800 PR221-I In800	8000	AF580	E800DU800	250	800	580
355	610	T6H800 PR221-I In800	8000	AF750	E800DU800	250	800	650



# Motor protection

## DOL Type 2 - Normal starting

**DOL @ 400/415 V - 80 kA - Type 2 - Normal starting**

Motor		MCCB		Contactor	Thermal release			Group
Rated Power <b>Pe</b> [kW]	Rated current <b>Ie</b> [A]	Type	Setting of the magnetic release [A]	Type	Type	Current setting		I max [A]
						min [A]	max [A]	
0.37	1.1	T2L160 MF 1.6	21	A9	TA25DU1.4	1	1.4	1.4
0.55	1.5	T2L160 MF 1.6	21	A9	TA25DU1.8	1.3	1.8	1.6
0.75	1.9	T2L160 MF 2	26	A9	TA25DU2.4	1.7	2.4	2
1.1	2.8	T2L160 MF 3.2	42	A16	TA25DU4	2.8	4	3.2
1.5	3.5	T2L160 MF 4	52	A26	TA25DU5	3.5	5	4
2.2	5	T2L160 MF 5	65	A26	TA25DU6.5	4.5	6.5	5
3	6.6	T2L160 MF 8.5	110	A26	TA25DU8.5	6	8.5	8.5
4	8.6	T2L160 MF 11	145	A30	TA25DU11	7.5	11	11
5.5	11.5	T2L160 MF 12.5	163	A50	TA25DU14	10	14	12.5
7.5	15.2	T2L160 MA 20	210	A50	TA25DU19	13	19	19
11	22	T2L160 MA 32	288	A50	TA42DU25	18	25	25
15	28.5	T2L160 MA 52	392	A50	TA75DU42	29	42	42
18.5	36	T2L160 MA 52	469	A50	TA75DU52	36	52	50
22	42	T2L160 MA 52	547	A50	TA75DU52	36	52	50
30	56	T2L160 MA 80	840	A63	TA75DU80	60	80	65
37	68	T2L160 MA 80	960	A75	TA75DU80	60	80	75
45	83	T2L160 MA 100	1200	A95	TA110DU110	80	110	96
55	98	T4L250 PR221-I In160	1360	A110	TA110DU110	80	110	110
75	135	T4L250 PR221-I In250	1875	A145	E200DU200	60	200	145
90	158	T4L250 PR221-I In250	2500	A185	E200DU200	60	200	185
110	193	T4L320 PR221-I In320	2720	A210	E320DU320	100	320	210
132	232	T5L400 PR221-I In400	3200	A260	E320DU320	100	320	260
160	282	T5L400 PR221-I In400	4000	A300	E320DU320	100	320	300
200	349	T5L630 PR221-I In630	5040	AF400	E500DU500	150	500	400
250	430	T6L630 PR221-I In630	6300	AF460	E500DU500	150	500	430
290	520	T6L800 PR221-I In800	7200	AF580	E800DU800	250	800	580
315	545	T6L800 PR221-I In800	8000	AF580	E800DU800	250	800	580
355	610	T6L800 PR221-I In800	8000	AF750	E800DU800	250	800	750

3

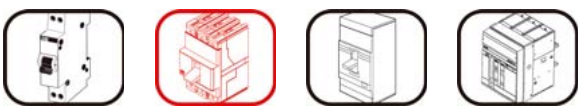

# Motor protection

## DOL Type 2 - Normal starting

### DOL @ 440 V - 50 kA - Type 2 - Normal starting

Motor		MCCB		Contactor	Thermal release			Group
Rated Power Pe [kW]	Rated current Ie [A]	Type	Setting of the magnetic release [A]	Type	Type	Current setting		I max [A]
						min [A]	max [A]	
0.37	1	T2H160 MF 1	13	A9	TA25DU1.4	1	1.4	1
0.55	1.4	T2H160 MF 1.6	21	A9	TA25DU1.8	1.3	1.8	1.6
0.75	1.7	T2H160 MF 2	26	A9	TA25DU2.4	1.7	2.4	2
1.1	2.2	T2H160 MF 2.5	33	A9	TA25DU3.1	2.2	3.1	2.5
1.5	3	T2H160 MF 3.2	42	A16	TA25DU4	2.8	4	3.2
2.2	4.4	T2H160 MF 5	65	A26	TA25DU5	3.5	5	5
3	5.7	T2H160 MF 6.5	84	A26	TA25DU6.5	4.5	6.5	6.5
4	7.8	T2H160 MF 8.5	110	A30	TA25DU11	7.5	11	8.5
5.5	10.5	T2H160 MF 11	145	A30	TA25DU14	10	14	11
7.5	13.5	T2H160 MA 20	180	A30	TA25DU19	13	19	19
11	19	T2H160 MA 32	240	A30	TA42DU25	18	25	25
15	26	T2H160 MA 32	336	A50	TA75DU32	22	32	32
18.5	32	T2H160 MA 52	469	A50	TA75DU42	29	42	42
22	38	T2H160 MA 52	547	A50	TA75DU52	36	52	45
30	52	T2H160 MA 80	720	A63	TA75DU63	45	63	63
37	63	T2H160 MA 80	840	A75	TA75DU80	60	80	70
45	75	T2H160 MA 100	1050	A95	TA110DU90	65	90	90
55	90	T4H250 PR221-I In160	1200	A110	TA110DU110	80	110	100
75	120	T4H250 PR221-I In250	1750	A145	E200DU200	60	200	145
90	147	T4H250 PR221-I In250	2000	A185	E200DU200	60	200	185
110	177	T4H250 PR221-I In250	2500	A210	E320DU320	100	320	210
132	212	T5H400 PR221-I In320	3200	A260	E320DU320	100	320	220
160	260	T5H400 PR221-I In400	3600	A300	E320DU320	100	320	280
200	320	T5H630 PR221-I In630	4410	AF400	E500DU500	150	500	400
250	410	T6H630 PR221-I In630	5355	AF460	E500DU500	150	500	430
290	448	T6H630 PR221-I In630	6300	AF580	E500DU500*	150	500	500
315	500	T6H800 PR221-I In800	7200	AF580	E800DU800	250	800	580
355	549	T6H800 PR221-I In800	8000	AF580	E800DU800	250	800	580

\* Connection Kit not available. To use the connection kit, replace with relay E800DU800



# Motor protection

## DOL Type 2 - Normal starting

**DOL @ 440 V - 65 kA - Type 2 - Normal starting**

Motor		MCCB		Contactor	Thermal release			Group
Rated Power  Pe [kW]	Rated current  Ie [A]	Type	Setting of the magnetic release  [A]	Type	Type	Current setting		I max  [A]
						min [A]	max [A]	
0.37	1	T2L160 MF 1	13	A9	TA25DU1.4	1	1.4	1
0.55	1.4	T2L160 MF 1.6	21	A9	TA25DU1.8	1.3	1.8	1.6
0.75	1.7	T2L160 MF 2	26	A9	TA25DU2.4	1.7	2.4	2
1.1	2.2	T2L160 MF 2.5	33	A9	TA25DU3.1	2.2	3.1	2.5
1.5	3	T2L160 MF 3.2	42	A16	TA25DU4	2.8	4	3.2
2.2	4.4	T2L160 MF 5	65	A26	TA25DU5	3.5	5	5
3	5.7	T2L160 MF 6.5	84	A26	TA25DU6.5	4.5	6.5	6.5
4	7.8	T2L160 MF 8.5	110	A30	TA25DU11	7.5	11	8.5
5.5	10.5	T2L160 MF 11	145	A30	TA25DU14	10	14	11
7.5	13.5	T2L160 MA 20	180	A30	TA25DU19	13	19	19
11	19	T2L160 MA 32	240	A30	TA42DU25	18	25	25
15	26	T2L160 MA 32	336	A50	TA75DU32	22	32	32
18.5	32	T2L160 MA 52	469	A50	TA75DU42	29	42	42
22	38	T2L160 MA 52	547	A50	TA75DU52	36	52	45
30	52	T2L160 MA 80	720	A63	TA75DU63	45	63	63
37	63	T2L160 MA 80	840	A75	TA75DU80	60	80	70
45	75	T2L160 MA 100	1050	A95	TA110DU90	65	90	90
55	90	T4H250 PR221-I In160	1200	A110	TA110DU110	80	110	100
75	120	T4H250 PR221-I In250	1750	A145	E200DU200	60	200	145
90	147	T4H250 PR221-I In250	2000	A185	E200DU200	60	200	185
110	177	T4H250 PR221-I In250	2500	A210	E320DU320	100	320	210
132	212	T5H400 PR221-I In320	3200	A260	E320DU320	100	320	220
160	260	T5H400 PR221-I In400	3600	A300	E320DU320	100	320	280
200	320	T5H630 PR221-I In630	4410	AF400	E500DU500	150	500	400
250	410	T6L630 PR221-I In630	5355	AF460	E500DU500	150	500	430
290	448	T6L630 PR221-I In630	6300	AF580	E500DU500*	150	500	500
315	500	T6L800 PR221-I In800	7200	AF580	E800DU800	250	800	580
355	549	T6L800 PR221-I In800	8000	AF580	E800DU800	250	800	580

\* Connection Kit not available. To use the connection kit, replace with relay E800DU800





# Motor protection

## DOL Type 2 - Normal starting

### DOL @ 500 V - 50 kA - Type 2 - Normal starting

Motor		MCCB		Contactor	Thermal release			Group
Rated Power Pe [kW]	Rated current Ie [A]	Type	Setting of the magnetic release [A]	Type	Type	Current setting		I max [A]
						min [A]	max [A]	
0.37	0.88	T2L160 MF 1	13	A9	TA25DU1.0	0.63	1	1
0.55	1.2	T2L160 MF 1.6	21	A9	TA25DU1.4	1	1.4	1.4
0.75	1.5	T2L160 MF 1.6	21	A9	TA25DU1.8	1.3	1.8	1.6
1.1	2.2	T2L160 MF 2.5	33	A9	TA25DU3.1	2.2	3.1	2.5
1.5	2.8	T2L160 MF 3.2	42	A16	TA25DU4	2.8	4	3.2
2.2	4	T2L160 MF 4	52	A26	TA25DU5	3.5	5	4
3	5.2	T2L160 MF 6.5	84	A26	TA25DU6.5	4.5	6.5	6.5
4	6.9	T2L160 MF 8.5	110	A30	TA25DU8.5	6	8.5	8.5
5.5	9.1	T2L160 MF 11	145	A30	TA25DU11	7.5	11	11
7.5	12.2	T2L160 MF 12.5	163	A30	TA25DU14	10	14	12.5
11	17.5	T2L160 MA 20	240	A30	TA25DU19	13	19	19
15	23	T2L160 MA 32	336	A50	TA75DU25	18	25	25
18.5	29	T2L160 MA 52	392	A50	TA75DU32	22	32	32
22	34	T2L160 MA 52	469	A50	TA75DU42	29	42	42
30	45	T2L160 MA 52	624	A63	TA75DU52	36	52	52
37	56	T2L160 MA 80	840	A75	TA75DU63	45	63	63
45	67	T2L160 MA 80	960	A95	TA80DU80	60	80	80
55	82	T2L160 MA 100	1200	A110	TA110DU90	65	90	90
75	110	T4H250 PR221-I In160	1440	A145	E200DU200	60	200	145
90	132	T4H250 PR221-I In250	1875	A145	E200DU200	60	200	145
110	158	T4H250 PR221-I In250	2250	A185	E200DU200	60	200	170
132	192	T4H320 PR221-I In320	2720	A210	E320DU320	100	320	210
160	230	T5H400 PR221-I In400	3600	A260	E320DU320	100	320	240
200	279	T5H400 PR221-I In400	4000	A300	E320DU320	100	320	280
250	335	T5H630 PR221-I In630	4725	AF400	E500DU500	150	500	400
290	394	T6L630 PR221-I In630	5040	AF460	E500DU500	150	500	430
315	440	T6L630 PR221-I In630	6300	AF580	E500DU500*	150	500	500
355	483	T6L630 PR221-I In630	6300	AF580	E800DU800	250	800	500

\* Connection Kit not available. To use the connection kit, replace with relay E800DU800



# Motor protection

## DOL Type 2 - Normal starting

### DOL @ 690 V - 50 kA - Type 2 - Normal starting

Motor		MCCB		Contactor	TC		Thermal release		Group
Rated Power <b>Pe</b> [kW]	Rated current <b>Ie</b> [A]	Type	Setting of the magnetic release [A]	Type	KORC	No. of turns of the CT primary coil	Current setting		I max [A]
							min [A]	max [A]	
0.37	0.6	T2L160 MF1	13	A9			TA25DU0.63	0.4 0.63	0.63
0.55	0.9	T2L160 MF1	13	A9			TA25DU1	0.63 1	1
0.75	1.1	T2L160 MF1.6	21	A9			TA25DU1.4	1 1.4	1.4
1.1	1.6	T2L160 MF1.6	21	A9			TA25DU1.8	1.3 1.8	1.6
1.5	2	T2L160 MF2.5	33	A9			TA25DU2.4	1.7 2.4	2.4
2.2	2.9	T2L160 MF3.2	42	A9			TA25DU3.1 *	2.2 3.1	3.1
3	3.8	T2L160 MF4	52	A9			TA25DU4 *	2.8 4	4
4	5	T2L160 MF5	65	A9			TA25DU5 *	3.5 5	5
5.5	6.5	T2L160 MF6.5	84	A9			TA25DU6.5 *	4.5 6.5	6.5
		T4L250 PR221-I In 100	150	A95	4L185R/4	13**	TA25DU2.4	6 8.5	8.5
7.5	8.8	T4L250 PR221-I In 100	150	A95	4L185R/4	10**	TA25DU2.4	7.9 11.1	11.1
11	13	T4L250 PR221-I In 100	200	A95	4L185R/4	7**	TA25DU2.4	11.2 15.9	15.9
15	18	T4L250 PR221-I In 100	250	A95	4L185R/4	7**	TA25DU3.1	15.2 20.5	20.5
18.5	21	T4L250 PR221-I In 100	300	A95	4L185R/4	6	TA25DU3.1	17.7 23.9	23.9
22	25	T4L250 PR221-I In 100	350	A95	4L185R/4	6	TA25DU4	21.6 30.8	30.8
30	33	T4L250 PR221-I In 100	450	A145	4L185R/4	6	TA25DU5	27 38.5	38.5
37	41	T4L250 PR221-I In 100	550	A145	4L185R/4	4	TA25DU4	32.4 46.3	46.3
45	49	T4L250 PR221-I In 100	700	A145	4L185R/4	4	TA25DU5	40.5 57.8	57.8
55	60	T4L250 PR221-I In 100	800	A145	4L185R/4	3	TA25DU5	54 77.1	77.1
75	80	T4L250 PR221-I In 160	1120	A145			E200DU200	65 200	120
90	95	T4L250 PR221-I In 160	1280	A145			E200DU200	65 200	120
110	115	T4L250 PR221-I In 250	1625	A145			E200DU200	65 200	120
132	139	T4L250 PR221-I In 250	2000	A185			E200DU200	65 200	170
160	167	T4L250 PR221-I In 250	2250	A185			E200DU200	65 200	170
200	202	T5L400 PR221-I In 320	2720	A210			E320DU320	105 320	210
250	242	T5L400 PR221-I In 400	3400	A300			E320DU320	105 320	280
290	301	T5L630 PR221-I In 630	4410	AF400			E500DU500	150 500	350
315	313	T5L630 PR221-I In 630	4410	AF400			E500DU500	150 500	350
355	370	T5L630 PR221-I In 630	5355	AF580			E500DU500***	150 500	430

For further information about the KORC, please see the "Brochure KORC 1 GB 00-04" catalogue.

\* Type 1 coordination

\*\* Cable cross section= 4 mm<sup>2</sup>

\*\*\* No mounting kit to contactor is available; to use mounting kit provide E800DU



# Motor protection

## DOL Type 2 - Heavy duty

**DOL @ 400/415 V - 35 kA - Type 2 - Heavy duty**

Motor		MCCB		Contactor	Thermal release			Group	
Rated Power Pe [kW]	Rated current Ie [A]	Type	Setting of the magnetic release [A]	Type	Type**	No. of turns of the CT primary coil	Current setting min   max [A]   [A]		I max [A]
0.37	1.1	T2N160 MF1.6	21	A9	TA25DU1.4*		1	1.4	1.4
0.55	1.5	T2N160 MF1.6	21	A9	TA25DU1.8*		1.3	1.8	1.6
0.75	1.9	T2N160 MF 2	26	A9	TA25DU2.4*		1.7	2.4	2
1.1	2.8	T2N160 MF 3.2	42	A9	TA25DU4*		2.8	4	3.2
1.5	3.5	T2N160 MF 4	52	A16	TA25DU5*		3.5	5	4
2.2	5	T2N160 MF 5	65	A26	TA25DU6.5*		4.5	6.5	5
3	6.6	T2N160 MF 8.5	110	A26	TA25DU8.5*		6	8.5	8.5
4	8.6	T2N160 MF 11	145	A30	TA25DU11*		7.5	11	11
5.5	11.5	T2N160 MF 12.5	163	A30	TA450SU60	4	10	15	12.5
7.5	15.2	T2N160 MA 20	210	A30	TA450SU60	3	13	20	20
11	22	T2N160 MA 32	288	A30	TA450SU60	2	20	30	32
15	28.5	T2N160 MA 52	392	A50	TA450SU80	2	23	40	40
18.5	36	T2N160 MA 52	469	A50	TA450SU80	2	23	40	40
22	42	T2N160 MA 52	547	A50	TA450SU60		40	60	50
30	56	T2N160 MA 80	840	A63	TA450SU80		55	80	65
37	68	T2N160 MA 80	960	A95	TA450SU80		55	80	80
45	83	T2N160 MA 100	1200	A110	TA450SU105		70	105	100
55	98	T3N250 MA 160	1440	A145	TA450SU140		95	140	140
75	135	T3N250 MA 200	1800	A185	TA450SU185		130	185	185
90	158	T3N250 MA 200	2400	A210	TA450SU185		130	185	185
110	193	T4N320 PR221-I In320	2720	A260	E320DU320		100	320	220
132	232	T5N400 PR221-I In400	3200	A300	E320DU320		100	320	300
160	282	T5N400 PR221-I In400	4000	AF400	E500DU500		150	500	400
200	349	T5N630 PR221-I In630	5040	AF460	E500DU500		150	500	430
250	430	T6N630 PR221-I In630	6300	AF580	E500DU500***		150	500	430
290	520	T6N800 PR221-I In800	7200	AF750	E800DU800		250	800	750
315	545	T6N800 PR221-I In800	8000	AF750	E800DU800		250	800	750
355	610	T6N800 PR221-I In800	8000	AF750	E800DU800		250	800	750

\* Provide a by-pass contactor of the same size during motor start-up

\*\* Set trip class 30 on the Type E relays

\*\*\* Connection Kit not available. To use the connection kit, replace with relay E800DU800



# Motor protection

## DOL Type 2 - Heavy duty

**DOL @ 400/415 V - 50 kA - Type 2 - Heavy duty**

Motor		MCCB		Contactor	Thermal release			Group	
Rated Power Pe [kW]	Rated current Ie [A]	Type	Setting of the magnetic release [A]	Type	Type**	No. of turns of the CT primary coil	Current setting		I max [A]
							min [A]	max [A]	
0.37	1.1	T2S160 MF 1.6	21	A9	TA25DU1.4*		1	1.4	1.4
0.55	1.5	T2S160 MF 1.6	21	A9	TA25DU1.8*		1.3	1.8	1.6
0.75	1.9	T2S160 MF 2	26	A9	TA25DU2.4*		1.7	2.4	2
1.1	2.8	T2S160 MF 3.2	42	A9	TA25DU4*		2.8	4	3.2
1.5	3.5	T2S160 MF 4	52	A16	TA25DU5*		3.5	5	4
2.2	5	T2S160 MF 5	65	A26	TA25DU6.5*		4.5	6.5	5
3	6.6	T2S160 MF 8.5	110	A26	TA25DU8.5*		6	8.5	8.5
4	8.6	T2S160 MF 11	145	A30	TA25DU11*		7.5	11	11
5.5	11.5	T2S160 MF 12.5	163	A30	TA450SU60	4	10	15	12.5
7.5	15.2	T2S160 MA 20	210	A30	TA450SU60	3	13	20	20
11	22	T2S160 MA 32	288	A30	TA450SU60	2	20	30	32
15	28.5	T2S160 MA 52	392	A50	TA450SU80	2	23	40	40
18.5	36	T2S160 MA 52	469	A50	TA450SU80	2	23	40	40
22	42	T2S160 MA 52	547	A50	TA450SU60		40	60	50
30	56	T2S160 MA 80	840	A63	TA450SU80		55	80	65
37	68	T2S160 MA 80	960	A95	TA450SU80		55	80	80
45	83	T2S160 MA 100	1200	A110	TA450SU105		70	105	100
55	98	T3S250 MA 160	1440	A145	TA450SU140		95	140	140
75	135	T3S250 MA 200	1800	A185	TA450SU185		130	185	185
90	158	T3S250 MA 200	2400	A210	TA450SU185		130	185	185
110	193	T4S320 PR221-I In320	2720	A260	E320DU320		100	320	220
132	232	T5S400 PR221-I In400	3200	A300	E320DU320		100	320	300
160	282	T5S400 PR221-I In400	4000	AF400	E500DU500		150	500	400
200	349	T5S630 PR221-I In630	5040	AF460	E500DU500		150	500	430
250	430	T6S630 PR221-I In630	6300	AF580	E500DU500***		150	500	430
290	520	T6S800 PR221-I In800	7200	AF750	E800DU800		250	800	750
315	545	T6S800 PR221-I In800	8000	AF750	E800DU800		250	800	750
355	610	T6S800 PR221-I In800	8000	AF750	E800DU800		250	800	750

\* Provide a by-pass contactor of the same size during motor start-up

\*\* Set trip class 30 on the Type E relays

\*\*\* Connection Kit not available. To use the connection kit, replace with relay E800DU800



# Motor protection

## DOL Type 2 - Heavy duty

**DOL @ 440 V - 50 kA - Type 2 - Heavy duty**

Motor		MCCB		Contactor	Thermal release			Group	
Rated Power Pe [kW]	Rated current Ie [A]	Type	Setting of the magnetic release [A]	Type	Type**	No. of turns of the CT primary coil	Current setting		I max [A]
							min [A]	max [A]	
0.37	1	T2H160 MF 1	13	A9	TA25DU1.4*		1	1.4	1
0.55	1.4	T2H160 MF 1.6	21	A9	TA25DU1.8*		1.3	1.8	1.6
0.75	1.7	T2H160 MF 2	26	A9	TA25DU2.4*		1.7	2.4	2
1.1	2.2	T2H160 MF 2.5	33	A9	TA25DU3.1*		2.2	3.1	2.5
1.5	3	T2H160 MF 3.2	42	A16	TA25DU4*		2.8	4	3.2
2.2	4.4	T2H160 MF 5	65	A26	TA25DU5*		3.5	5	5
3	5.7	T2H160 MF 6.5	84	A26	TA25DU6.5*		4.5	6.5	6.5
4	7.8	T2H160 MF 8.5	110	A30	TA25DU11*		7.5	11	8.5
5.5	10.5	T2H160 MF 11	145	A30	TA25DU14*		10	14	11
7.5	13.5	T2H160 MA 20	180	A30	TA450SU60	4	10	15	15
11	19	T2H160 MA 32	240	A30	TA450SU80	3	18	27	27
15	26	T2H160 MA 32	336	A50	TA450SU60	2	20	30	32
18.5	32	T2H160 MA 52	469	A50	TA450SU80	2	28	40	40
22	38	T2H160 MA 52	547	A50	TA450SU80	2	28	40	40
30	52	T2H160 MA 80	720	A63	TA450SU60		40	60	60
37	63	T2H160 MA 80	840	A95	TA450SU80		55	80	80
45	75	T2H160 MA 100	1050	A110	TA450SU105		70	105	100
55	90	T4H250 PR221-I In160	1200	A145	E200DU200		60	200	145
75	120	T4H250 PR221-I In250	1750	A185	E200DU200		60	200	185
90	147	T4H250 PR221-I In250	2000	A210	E320DU320		100	320	210
110	177	T4H250 PR221-I In250	2500	A260	E320DU320		100	320	220
132	212	T5H400 PR221-I In320	3200	A300	E320DU320		100	320	220
160	260	T5H400 PR221-I In400	3600	AF400	E500DU500		150	500	400
200	320	T5H630 PR221-I In630	4410	AF460	E500DU500		150	500	430
250	410	T6H630 PR221-I In630	5355	AF580	E500DU500***		150	500	430
290	448	T6H630 PR221-I In630	6300	AF750	E500DU500***		150	500	500
315	500	T6H800 PR221-I In800	7200	AF 750	E800DU800		250	800	750
355	549	T6H800 PR221-I In800	8000	AF 750	E800DU800		250	800	750

\* Provide a by-pass contactor of the same size during motor start-up

\*\* Set trip class 30 on the Type E relays

\*\*\* Connection Kit not available. To use the connection kit, replace with relay E800DU800



# Motor protection

## DOL Type 2 - Heavy duty

**DOL @ 440 V - 65 kA - Type 2 - Heavy duty**

Motor		MCCB		Contactor	Thermal release			Group	
Rated Power <b>Pe</b> [kW]	Rated current <b>Ie</b> [A]	Type	Setting of the magnetic release [A]	Type	Type**	No. of turns of the CT primary coil	Current setting		I max [A]
							min [A]	max [A]	
0.37	1	T2L160 MF 1	13	A9	TA25DU1.4*		1	1.4	1
0.55	1.4	T2L160 MF 1.6	21	A9	TA25DU1.8*		1.3	1.8	1.6
0.75	1.7	T2L160 MF 2	26	A9	TA25DU2.4*		1.7	2.4	2
1.1	2.2	T2L160 MF 2.5	33	A9	TA25DU3.1*		2.2	3.1	2.5
1.5	3	T2L160 MF 3.2	42	A16	TA25DU4*		2.8	4	3.2
2.2	4.4	T2L160 MF 5	65	A26	TA25DU5*		3.5	5	5
3	5.7	T2L160 MF 6.5	84	A26	TA25DU6.5*		4.5	6.5	6.5
4	7.8	T2L160 MF 8.5	110	A30	TA25DU11*		7.5	11	8.5
5.5	10.5	T2L160 MF 11	145	A30	TA25DU14*		10	14	11
7.5	13.5	T2L160 MA 20	180	A30	TA450SU60	4	10	15	15
11	19	T2L160 MA 32	240	A30	TA450SU80	3	18	27	27
15	26	T2L160 MA 32	336	A50	TA450SU60	2	20	30	32
18.5	32	T2L160 MA 52	469	A50	TA450SU80	2	28	40	40
22	38	T2L160 MA 52	547	A50	TA450SU80	2	28	40	40
30	52	T2L160 MA 80	720	A63	TA450SU60		40	60	60
37	63	T2L160 MA 80	840	A95	TA450SU80		55	80	80
45	75	T2L160 MA 100	1050	A110	TA450SU105		70	105	100
55	90	T4H250 PR221-I In160	1200	A145	E200DU200		60	200	145
75	120	T4H250 PR221-I In250	1750	A185	E200DU200		60	200	185
90	147	T4H250 PR221-I In250	2000	A210	E320DU320		100	320	210
110	177	T4H250 PR221-I In250	2500	A260	E320DU320		100	320	220
132	212	T5H400 PR221-I In320	3200	A300	E320DU320		100	320	220
160	260	T5H400 PR221-I In400	3600	AF400	E500DU500		150	500	400
200	320	T5H630 PR221-I In630	4410	AF460	E500DU500		150	500	430
250	410	T6L630 PR221-I In630	5355	AF580	E500DU500***		150	500	430
290	448	T6L630 PR221-I In630	6300	AF750	E500DU500***		150	500	500
315	500	T6L800 PR221-I In800	7200	AF750	E800DU800		250	800	750
355	549	T6L800 PR221-I In800	8000	AF750	E800DU800		250	800	750

\* Provide a by-pass contactor of the same size during motor start-up  
 \*\* Set trip class 30 on the Type E relays  
 \*\*\* Connection Kit not available. To use the connection kit, replace with relay E800DU800



# Motor protection

## DOL Type 2 - Heavy duty

### DOL @ 500 V - 50 kA - Type 2 - Heavy duty

Motor		MCCB		Contactor	Thermal release			Group	
Rated Power Pe [kW]	Rated current Ie [A]	Type	Setting of the magnetic release [A]	Type	Type**	No. of turns of the CT primary coil	Current setting min   max [A]   [A]		I max [A]
0.37	0.88	T2L160 MF 1	13	A9	TA25DU1.0*		0.63	1	1
0.55	1.2	T2L160 MF 1.6	21	A9	TA25DU1.4*		1	1.4	1.4
0.75	1.5	T2L160 MF 1.6	21	A9	TA25DU1.8*		1.3	1.8	1.6
1.1	2.2	T2L160 MF 2.5	33	A9	TA25DU3.1*		2.2	3.1	2.5
1.5	2.8	T2L160 MF 3.2	42	A16	TA25DU4*		2.8	4	3.2
2.2	4	T2L160 MF 4	52	A26	TA25DU5*		3.5	5	4
3	5.2	T2L160 MF 6.5	84	A26	TA25DU6.5*		4.5	6.5	6.5
4	6.9	T2L160 MF 8.5	110	A30	TA25DU8.5*		6	8.5	8.5
5.5	9.1	T2L160 MF 11	145	A30	TA25DU11*		7.5	11	11
7.5	12.2	T2L160 MF 12.5	163	A30	TA450SU60	4	10	15	12.5
11	17.5	T2L160 MA 20	240	A30	TA450SU60	3	13	20	20
15	23	T2L160 MA 32	336	A50	TA450SU60	2	20	30	30
18.5	29	T2L160 MA 52	392	A50	TA450SU80	2	27.5	40	40
22	34	T2L160 MA 52	469	A50	TA450SU80	2	27.5	40	40
30	45	T2L160 MA 52	624	A63	TA450SU60		40	60	52
37	56	T2L160 MA 80	840	A75	TA450SU60		40	60	60
45	67	T2L160 MA 80	960	A95	TA450SU80		55	80	80
55	82	T2L160 MA 100	1200	A145	TA450SU105		70	105	100
75	110	T4H250 PR221-I In160	1440	A145	E200DU200		60	200	145
90	132	T4H250 PR221-I In250	1875	A185	E200DU200		60	200	170
110	158	T4H250 PR221-I In250	2125	A210	E320DU320		100	320	210
132	192	T4H320 PR221-I In320	2720	A260	E320DU320		100	320	220
160	230	T5H400 PR221-I In400	3200	A300	E320DU320		100	320	280
200	279	T5H400 PR221-I In400	3600	AF400	E500DU500		150	500	400
250	335	T5H630 PR221-I In630	4725	AF460	E500DU500		150	500	430
290	394	T6L630 PR221-I In630	5040	AF580	E500DU500***		150	500	430
315	440	T6L630 PR221-I In630	6300	AF750	E500DU500***		150	500	500
355	483	T6L630 PR221-I In630	6300	AF750	E500DU500***		150	500	500

\* Provide a by-pass contactor of the same size during motor start-up

\*\* Set trip class 30 on the Type E relays

\*\*\* Connection Kit not available. To use the connection kit, replace with relay E800DU800





# Motor protection

## DOL Type 2 - Heavy duty

**DOL @ 690 V - 50 kA - Type 2 - Heavy duty**

Motor		MCCB		Contactor	Thermal release			Group	
Rated Power <b>Pe</b> [kW]	Rated current <b>Ie</b> [A]	Type	Setting of the magnetic release [A]	Type	Type**	No. of turns of the CT primary coil	Current setting		I max [A]
							min [A]	max [A]	
0.37	0.6	T2L160 MF1	13	A9	TA25DU0.63 <sup>(X)</sup>		0.4	0.63	0.63
0.55	0.9	T2L160 MF1	13	A9	TA25DU1 <sup>(X)</sup>		0.63	1	1
0.75	1.1	T2L160 MF1.6	21	A9	TA25DU1.4 <sup>(X)</sup>		1	1.4	1.4
1.1	1.6	T2L160 MF1.6	21	A9	TA25DU1.8 <sup>(X)</sup>		1.3	1.8	1.6
1.5	2	T2L160 MF2.5	33	A9	TA25DU2.4 <sup>(X)</sup>		1.7	2.4	2.4
2.2	2.9	T2L160 MF3.2	42	A9	TA25DU3.1 <sup>*(X)</sup>		2.2	3.1	3.1
3	3.8	T2L160 MF4	52	A9	TA25DU4 <sup>*(X)</sup>		2.8	4	4
4	5	T2L160 MF5	65	A9	TA25DU5 <sup>*(X)</sup>		3.5	5	5
5.5	6.5	T2L160 MF6.5	84	A9	TA25DU6.5 <sup>*(X)</sup>		4.5	6.5	6.5
		T4L250 PR221-I In 100	150	A95	TA450SU60	7**	5.7	8.6	8.5
7.5	8.8	T4L250 PR221-I In 100	150	A95	TA450SU60	5**	8	12	12
11	13	T4L250 PR221-I In 100	200	A95	TA450SU60	4**	10	15	15
15	18	T4L250 PR221-I In 100	250	A95	TA450SU60	3**	13	20	20
18.5	21	T4L250 PR221-I In 100	300	A95	TA450SU80	3	18	27	27
22	25	T4L250 PR221-I In 100	350	A95	TA450SU60	2	20	30	30
30	33	T4L250 PR221-I In 100	450	A145	TA450SU80	2	27.5	40	40
37	41	T4L250 PR221-I In 100	550	A145	TA450SU60		40	60	60
45	49	T4L250 PR221-I In 100	700	A145	TA450SU60		40	60	60
55	60	T4L250 PR221-I In 100	800	A145	TA450SU80		55	80	80
75	80	T4L250 PR221-I In 160	1120	A145	TA450SU105		70	105	105
90	95	T4L250 PR221-I In 160	1280	A145	TA450SU105		70	105	105
110	115	T4L250 PR221-I In 250	1625	A185	TA450SU140		95	140	140
132	139	T4L250 PR221-I In 250	2000	A210	E320DU320		105	320	210
160	167	T4L250 PR221-I In 250	2250	A210	E320DU320		105	320	210
200	202	T5L400 PR221-I In 320	2720	A260	E320DU320		105	320	220
250	242	T5L400 PR221-I In 400	3400	AF400	E500DU500		150	500	350
290	301	T5L630 PR221-I In 630	4410	AF400	E500DU500		150	500	350
315	313	T5L630 PR221-I In 630	4410	AF460	E500DU500		150	500	400
355	370	T5L630 PR221-I In 630	5355	AF580	E500DU500***		150	500	430

\* Type 1 coordination

\*\* Cable cross section= 4 mm<sup>2</sup>

\*\*\* No mounting kit to contactor is available; to use mounting kit provide E800DU800

(X) Provide a by-pass contactor of the same size during motor start-up.





# Motor protection

## Star-delta - Type 2

### Star-delta - Type 2 @ 400/415 V - 35 kA - 50/60 Hz

Motor		MCCB		Contactor			Thermal release	
Pe [kW]	Ie [A]	Type	Im [A]	line type	delta type	star type	type	[A]
18.5	36	T2N160 MA52	469	A50	A50	A26	TA75DU25	18-25
22	42	T2N160 MA52	547	A50	A50	A26	TA75DU32	22-32
30	56	T2N160 MA80	720	A63	A63	A30	TA75DU42	29-42
37	68	T2N160 MA80	840	A75	A75	A30	TA75DU52	36-52
45	83	T2N160 MA100	1050	A75	A75	A30	TA75DU63	45-63
55	98	T2N160 MA100	1200	A75	A75	A40	TA75DU63	45-63
75	135	T3N250 MA160	1700	A95	A95	A75	TA110DU90	66-90
90	158	T3N250 MA200	2000	A110	A110	A95	TA110DU110	80-110
110	193	T3N250 MA200	2400	A145	A145	A95	TA200DU135	100-135
132	232	T4N320 PR221-I In320	2880	A145	A145	A110	E200DU200	60-200
160	282	T5N400 PR221-I In400	3600	A185	A185	A145	E200DU200	60-200
200	349	T5N630 PR221-I In630	4410	A210	A210	A185	E320DU320	100-320
250	430	T5N630 PR221-I In630	5670	A260	A260	A210	E320DU320	100-320
290	520	T6N630 PR221-I In630	6300	AF400	AF400	A260	E500DU500	150-500
315	545	T6N800 PR221-I In800	7200	AF400	AF400	A260	E500DU500	150-500
355	610	T6N800 PR221-I In800	8000	AF400	AF400	A260	E500DU500	150-500

### Star-delta - Type 2 @ 400/415 V - 50 kA - 50/60 Hz

Motor		MCCB		Contactor			Thermal release	
Pe [kW]	Ie [A]	Type	Im [A]	line type	delta type	star type	type	[A]
18.5	36	T2S160 MA52	469	A50	A50	A26	TA75DU25	18-25
22	42	T2S160 MA52	547	A50	A50	A26	TA75DU32	22-32
30	56	T2S160 MA80	720	A63	A63	A30	TA75DU42	29-42
37	68	T2S160 MA80	840	A75	A75	A30	TA75DU52	36-52
45	83	T2S160 MA100	1050	A75	A75	A30	TA75DU63	45-63
55	98	T2S160 MA100	1200	A75	A75	A40	TA75DU63	45-63
75	135	T3S250 MA160	1700	A95	A95	A75	TA110DU90	66-90
90	158	T3S250 MA200	2000	A110	A110	A95	TA110DU110	80-110
110	193	T3S250 MA200	2400	A145	A145	A95	TA200DU135	100-135
132	232	T4S320 PR221-I In320	2880	A145	A145	A110	E200DU200	60-200
160	282	T5S400 PR221-I In400	3600	A185	A185	A145	E200DU200	60-200
200	349	T5S630 PR221-I In630	4410	A210	A210	A185	E320DU320	100-320
250	430	T5S630 PR221-I In630	5670	A260	A260	A210	E320DU320	100-320
290	520	T6S630 PR221-I In630	6300	AF400	AF400	A260	E500DU500	150-500
315	545	T6S800 PR221-I In800	7200	AF400	AF400	A260	E500DU500	150-500
355	610	T6S800 PR221-I In800	8000	AF400	AF400	A260	E500DU500	150-500



# Motor protection

## Star-delta - Type 2

### Star-delta - Type 2 @ 440 V - 50 kA - 50/60 Hz

Motor		MCCB		Contactor			Thermal release	
Pe [kW]	Ie [A]	Type	Im [A]	line type	delta type	star type	type	[A]
18.5	32	T2H160 MA52	392	A50	A50	A16	TA75DU25	18-25
22	38	T2H160 MA52	469	A50	A50	A26	TA75DU25	18-25
30	52	T2H160 MA80	720	A63	A63	A26	TA75DU42	29-42
37	63	T2H160 MA80	840	A75	A75	A30	TA75DU42	29-42
45	75	T2H160 MA80	960	A75	A75	A30	TA75DU52	36-52
55	90	T2H160 MA100	1150	A75	A75	A40	TA75DU63	45-63
75	120	T4H250 PR221-I In250	1625	A95	A95	A75	TA80DU80	60-80
90	147	T4H250 PR221-I In250	1875	A95	A95	A75	TA110DU110	80-110
110	177	T4H250 PR221-I In250	2250	A145	A145	A95	E200DU200	60-200
132	212	T4H320 PR221-I In320	2720	A145	A145	A110	E200DU200	60-200
160	260	T5H400 PR221-I In400	3200	A185	A185	A145	E200DU200	60-200
200	320	T5H630 PR221-I In630	4095	A210	A210	A185	E320DU320	100-320
250	410	T5H630 PR221-I In630	5040	A260	A260	A210	E320DU320	100-320
290	448	T6H630 PR221-I In630	5670	AF400	AF400	A260	E500DU500	150-500
315	500	T6H630 PR221-I In630	6300	AF400	AF400	A260	E500DU500	150-500
355	549	T6H800 PR221-I In800	7200	AF400	AF400	A260	E500DU500	150-500

3

### Star-delta - Type 2 @ 440 V - 65 kA - 50/60 Hz

Motor		MCCB		Contactor			Thermal release	
Pe [kW]	Ie [A]	Type	Im [A]	line type	delta type	star type	type	[A]
18.5	32	T2L160 MA52	392	A50	A50	A16	TA75DU25	18-25
22	38	T2L160 MA52	469	A50	A50	A26	TA75DU25	18-25
30	52	T2L160 MA80	720	A63	A63	A26	TA75DU42	29-42
37	63	T2L160 MA80	840	A75	A75	A30	TA75DU42	29-42
45	75	T2L160 MA80	960	A75	A75	A30	TA75DU52	36-52
55	90	T2L160 MA100	1150	A75	A75	A40	TA75DU63	45-63
75	120	T4H250 PR221-I In250	1625	A95	A95	A75	TA80DU80	60-80
90	147	T4H250 PR221-I In250	1875	A95	A95	A75	TA110DU110	80-110
110	177	T4H250 PR221-I In250	2250	A145	A145	A95	E200DU200	60-200
132	212	T4H320 PR221-I In320	2720	A145	A145	A110	E200DU200	60-200
160	260	T5H400 PR221-I In400	3200	A185	A185	A145	E200DU200	60-200
200	320	T5H630 PR221-I In630	4095	A210	A210	A185	E320DU320	100-320
250	410	T5H630 PR221-I In630	5040	A260	A260	A210	E320DU320	100-320
290	448	T6H630 PR221-I In630	5670	AF400	AF400	A260	E500DU500	150-500
315	500	T6H630 PR221-I In630	6300	AF400	AF400	A260	E500DU500	150-500
355	549	T6H800 PR221-I In800	7200	AF400	AF400	A260	E500DU500	150-500



# Motor protection

## Star-delta - Type 2

### Star-delta - Type 2 @ 500 V - 50 kA - 50/60 Hz

Motor		MCCB		Contactor			Thermal release	
Pe [kW]	Ie [A]	Type	Im [A]	line type	delta type	star type	type	[A]
22	34	T2L160 MA52	430	A50	A50	A16	TA75DU25	18-25
30	45	T2L160 MA52	547	A63	A63	A26	TA75DU32	22-32
37	56	T2L160 MA80	720	A75	A75	A30	TA75DU42	29-42
45	67	T2L160 MA80	840	A75	A75	A30	TA75DU52	36-52
55	82	T2L160 MA100	1050	A75	A75	A30	TA75DU52	36-52
75	110	T4H250 PR221-I In250	1375	A95	A95	A50	TA80DU80	60-80
90	132	T4H250 PR221-I In250	1750	A95	A95	A75	TA110DU90	65-90
110	158	T4H250 PR221-I In250	2000	A110	A110	A95	TA110DU110	80-110
132	192	T4H320 PR221-I In320	2560	A145	A145	A95	E200DU200	60-200
160	230	T4H320 PR221-I In320	2880	A145	A145	A110	E200DU200	60-200
200	279	T5H400 PR221-I In400	3400	A210	A210	A145	E320DU320	100-320
250	335	T5H630 PR221-I In630	4410	A210	A210	A185	E320DU320	100-320
290	394	T5H630 PR221-I In630	5040	A260	A260	A210	E320DU320	100-320
315	440	T6L630 PR221-I In630	5760	AF400	AF400	A210	E500DU500	150-500
355	483	T6L630 PR221-I In630	6300	AF400	AF400	A260	E500DU500	150-500

### Star-delta - Type 2 @ 690 V - 50 kA - 50/60 Hz

Motor		MCCB		Contactor			TC		Thermal release	
Pe [kW]	Ie [A]	Type	Im [A]	line type	delta type	star type	KORC	Coils	type	[A]
5.5	6.5*	T4L250 PR221-I In100	150	A95	A95	A26	4L185R/4**	13	TA25DU2.4**	6-8.5
7.5	8.8*	T4L250 PR221-I In100	150	A95	A95	A26	4L185R/4**	10	TA25DU2.4**	7.9-11.1
11	13*	T4L250 PR221-I In100	200	A95	A95	A26	4L185R/4**	7	TA25DU2.4**	11.2-15.9
15	18*	T4L250 PR221-I In100	250	A95	A95	A26	4L185R/4**	7	TA25DU3.1**	15.2-20.5
18.5	21	T4L250 PR221-I In100	300	A95	A95	A30	4L185R/4**	6	TA25DU3.1**	17.7-23.9
22	25	T4L250 PR221-I In100	350	A95	A95	A30	4L185R/4**	6	TA25DU4**	21.6-30.8
30	33	T4L250 PR221-I In100	450	A145	A145	A30	4L185R/4**	6	TA25DU5**	27-38.5
37	41	T4L250 PR221-I In100	550	A145	A145	A30			TA75DU52**	36-52
45	49	T4L250 PR221-I In100	650	A145	A145	A30			TA75DU52**	36-52
55	60	T4L250 PR221-I In100	800	A145	A145	A40			TA75DU52**	36-52
75	80	T4L250 PR221-I In160	1120	A145	A145	A50			TA75DU52	36-52
90	95	T4L250 PR221-I In160	1280	A145	A145	A75			TA75DU63	45-63
110	115	T4L250 PR221-I In160	1600	A145	A145	A75			TA75DU80	60-80
132	139	T4L250 PR221-I In250	1875	A145	A145	A95			TA200DU110	80-110
160	167	T4L250 PR221-I In250	2125	A145	A145	A110			TA200DU110	80-110
200	202	T4L320 PR221-I In320	2720	A185	A185	A110			TA200DU135	100-135
250	242	T5L400 PR221-I In400	3200	AF400	AF400	A145			E500DU500	150-500
290	301	T5L400 PR221-I In400	4000	AF400	AF400	A145			E500DU500	150-500
315	313	T5L630 PR221-I In630	4410	AF400	AF400	A185			E500DU500	150-500
355	370	T5L630 PR221-I In630	5040	AF400	AF400	A210			E500DU500	150-500
400	420	T5L630 PR221-I In630	5670	AF460	AF460	A210			E500DU500	150-500
450	470	T5L630 PR221-I In630	6300	AF460	AF460	A260			E500DU500	150-500

For further information about the KORC, please see the "Brochure KORC 1 GB 00-04" catalogue.

\* Cable cross section = 4 mm<sup>2</sup>

\*\* Connect the overload/relay upstream the line-delta mode.



# Motor protection

## DOL Type 2 - Start-up with MP release

### DOL @ 400/415 V - 35 kA - Type 2 - Start-up with MP release

Motor		MCCB			Contactor	Group
Pe [kW]	Ie [A]	Type	I <sub>1</sub> * [A]	I <sub>3</sub> [A]	type	I max [A]
30	56	T4N250 PR222MP In100	40-100	600	A95	95
37	68	T4N250 PR222MP In100	40-100	700	A95	95
45	83	T4N250 PR222MP In100	40-100	800	A95	95
55	98	T4N250 PR222MP In160	64-160	960	A145	145
75	135	T4N250 PR222MP In160	64-160	1280	A145	145
90	158	T4N250 PR222MP In200	80-200	1600	A185	185
110	193	T5N400 PR222MP In320	128-320	1920	A210	210
132	232	T5N400 PR222MP In320	128-320	2240	A260	260
160	282	T5N400 PR222MP In320	128-320	2560	AF400**	320
200	349	T5N400 PR222MP In400	160-400	3200	AF400	400
250	430	T6N800 PR222MP In630	252-630	5040	AF460	460
290	520	T6N800 PR222MP In630	252-630	5670	AF580	580
315	545	T6N800 PR222MP In630	252-630	5670	AF580	580
355	610	T6N800 PR222MP In630	252-630	5670	AF750	630

\* For heavy-duty start set the electronic release tripping class to class 30

\*\* In case of normal start use AF300

### DOL @ 400/415 V - 50 kA - Type 2 - Start-up with MP release

Motor		MCCB			Contactor	Group
Pe [kW]	Ie [A]	Type	I <sub>1</sub> * [A]	I <sub>3</sub> [A]	type	I max [A]
30	56	T4S250 PR222MP In100	40-100	600	A95	95
37	68	T4S250 PR222MP In100	40-100	700	A95	95
45	83	T4S250 PR222MP In100	40-100	800	A95	95
55	98	T4S250 PR222MP In160	64-160	960	A145	145
75	135	T4S250 PR222MP In160	64-160	1280	A145	145
90	158	T4S250 PR222MP In200	80-200	1600	A185	185
110	193	T5S400 PR222MP In320	128-320	1920	A210	210
132	232	T5S400 PR222MP In320	128-320	2240	A260	260
160	282	T5S400 PR222MP In320	128-320	2560	AF400**	320
200	349	T5S400 PR222MP In400	160-400	3200	AF400	400
250	430	T6S800 PR222MP In630	252-630	5040	AF460	460
290	520	T6S800 PR222MP In630	252-630	5670	AF580	580
315	545	T6S800 PR222MP In630	252-630	5670	AF580	580
355	610	T6S800 PR222MP In630	252-630	5670	AF750	630

\* For heavy-duty start set the electronic release tripping class to class 30

\*\* In case of normal start use AF300



# Motor protection

## DOL Type 2 - Start-up with MP release

### DOL @ 440 V - 50 kA - Type 2 - Start-up with MP release

Motor		MCCB			Contactor	Group
Pe [kW]	Ie [A]	Type	I <sub>1</sub> * [A]	I <sub>3</sub> [A]	type	I max [A]
30	52	T4H250 PR222MP In100	40-100	600	A95	93
37	63	T4H250 PR222MP In100	40-100	700	A95	93
45	75	T4H250 PR222MP In100	40-100	800	A95	93
55	90	T4H250 PR222MP In160	64-160	960	A145	145
75	120	T4H250 PR222MP In160	64-160	1120	A145	145
90	147	T4H250 PR222MP In200	80-200	1400	A185	185
110	177	T5H400 PR222MP In320	128-320	1920	A210	210
132	212	T5H400 PR222MP In320	128-320	2240	A260	240
160	260	T5H400 PR222MP In320	128-320	2560	AF400**	320
200	320	T5H400 PR222MP In400	160-400	3200	AF400	400
250	370	T6H800 PR222MP In630	252-630	4410	AF460	460
290	436	T6H800 PR222MP In630	252-630	5040	AF460	460
315	500	T6H800 PR222MP In630	252-630	5040	AF580	580
355	549	T6H800 PR222MP In630	252-630	5670	AF580	580

\* For heavy-duty start set the electronic release tripping class to class 30

\*\* In case of normal start use AF300

### DOL @ 500 V - 50 kA - Type 2 - Start-up with MP release

Motor		MCCB			Contactor	Group
Pe [kW]	Ie [A]	Type	I <sub>1</sub> * [A]	I <sub>3</sub> [A]	type	I max [A]
30	45	T4H250 PR222MP In100	40-100	600	A95	80
37	56	T4H250 PR222MP In100	40-100	600	A95	80
45	67	T4H250 PR222MP In100	40-100	700	A145	100
55	82	T4H250 PR222MP In100	40-100	800	A145	100
75	110	T4H250 PR222MP In160	64-160	1120	A145	145
90	132	T4H250 PR222MP In160	64-160	1280	A145	145
110	158	T4H250 PR222MP In200	80-200	1600	A185	170
132	192	T5H400 PR222MP In320	128-320	1920	A210	210
160	230	T5H400 PR222MP In320	128-320	2240	A260	260
200	279	T5H400 PR222MP In400	160-400	2800	AF400**	400
250	335	T5H400 PR222MP In400	160-400	3200	AF400	400
290	395	T6H800 PR222MP In630	252-630	5040	AF460	460
315	415	T6H800 PR222MP In630	252-630	5040	AF460	460
355	451	T6H800 PR222MP In630	252-630	5670	AF580	580

\* For heavy-duty start set the electronic release tripping class to class 30

\*\* In case of normal start use AF300



# Motor protection

## DOL Type 2 - Start-up with MP release

### DOL @ 690 V - 50 kA - Type 2 - Start-up with MP release

Motor		MCCB			Contactor	Group
Pe [kW]	Ie [A]	Type	I <sub>1</sub> * [A]	I <sub>3</sub> [A]	type	I max [A]
45	49	T4L250 PR222MP In100	40-100	600	A145	100
55	60	T4L250 PR222MP In100	40-100	600	A145	100
75	80	T4L250 PR222MP In100	40-100	800	A145	100
90	95	T4L250 PR222MP In160	64-160	960	A145	120
110	115	T4L250 PR222MP In160	64-160	1120	A145	120
132	139	T4L250 PR222MP In160	64-160	1440	A185	160
160	167	T4L250 PR222MP In200	80-200	1600	A185	170
200	202	T5L400 PR222MP In320	128-320	1920	A210	210
250	242	T5L400 PR222MP In320	128-320	2240	A300	280
290	301	T5L400 PR222MP In400	160-400	2800	AF400	350
315	313	T5L400 PR222MP In400	160-400	3200	AF400	350

\* For heavy-duty start set the electronic release tripping class to class 30

\*\* In case of normal start use AF300





---

## Coordination tables

### Switch-disconnectors

---

Notes for use.....	4/2
MCCB - MCS .....	4/4
MCCB - OT/OETL .....	4/5



---

## Switch-disconnectors

### Notes for use

---

The following tables give the coordination between circuit-breakers and switch-disconnectors of the following series: Tmax, Isomax, OT and OTEL.

The tables give the value of the maximum short-circuit current in kA for which protection between the combination of circuit-breaker - switch-disconnector is verified, for voltages up to 415 V.

The MCCB-OT-OETL tables are also valid at a voltage of 440 V. It is important to check that the breaking capacities at 440 V (present in the technical catalogues of the circuit-breakers) are compatible with the installation data.

With regard to the switch-disconnectors of the Emax series, on the other hand, it must be checked that the short-circuit current value at the point of installation is lower than the value of the short-time withstand current ( $I_{cw}$ ) of the switch-disconnector and that the peak current value is lower than the making capacity current value ( $I_{cm}$ ).

The protection against overload of the Emax switch-disconnector must also be checked. This can be carried out by means of an Emax series circuit-breaker of the same size.

Please consult the “Emax Low Voltage air circuit-breakers” technical catalogue for the characteristics of Emax switch-disconnectors.

# Switch-disconnectors

## Notes for use

### Note

The letter **T** indicates the switch-disconnector protection up to the breaking-capacity of the circuit-breaker.

The following tables give the breaking capacities at 415 V AC for Isomax and Tmax circuit-breakers.

Tmax @ 415 V AC	
Version	I <sub>cu</sub> [kA]
B	16
C	25
N	36
S	50
H	70
L (T2)	85
L (T4, T5)	120
L (T6)	100
V	200

Isomax @ 415 V AC	
Version	I <sub>cu</sub> [kA]
S	50
H	65
L	100

### Caption

MCS = switch-disconnectors derived from the moulded-case circuit-breakers (Tmax TD, Isomax SD)

MCCB = moulded-case circuit-breakers (Tmax, Isomax)

SD = switch-disconnectors

OT = OT series switch-disconnectors

OETL = OETL series switch-disconnectors

I<sub>th</sub> = traditional thermal current at 40 °C in free air

I<sub>cw</sub> = short-time withstand current r.m.s. for 1 second

For moulded-case or air circuit-breakers:

TM = thermomagnetic release

– TMD (Tmax)

– TMA (Tmax)

M = magnetic only release

– MF (Tmax)

– MA (Tmax)

EL = electronic release

– PR211/P - PR212/P (Isomax)

– PR221DS - PR222DS (Tmax)

### Caption of symbols



MCB Tmax Isomax Emax

For solutions not shown in these tables, please consult the website:

<http://bol.it.abb.com>

or contact ABB SACE

# Switch-disconnectors

Supply side circuit-breaker: MCCB

Load side switch-disconnectors: MCS

## MCCB - MCS @ 415 V

Supply s.	Version	Icu [kA]	Load s. Icw [kA]	T1D	T3D	T4D	T5D		T6D		S7D		
				2	3.6	3.6	6		15		25		
			Ith[A]	160	250	320	400	630	630	800	1000	1250	1600
			Iu[A]										
T1	B	16	160	16	16	16	16	16	16	16	16	16	16
	C	25		25	25	25	25	25	25	25	25	25	25
	N	36		36	36	36	36	36	36	36	36	36	36
T2	N	36	160	36	36	36	36	36	36	36	36	36	36
	S	50		50	50	50	50	50	50	50	50	50	
	H	70		70	70	70	70	70	70	70	70	70	
	L	85		85	85	85	85	85	85	85	85	85	
T3	N	36	250		36	36	36	36	36	36	36	36	36
	S	50			50	50	50	50	50	50	50	50	
T4	N	36	250 320		36*	36	36	36	36	36	36	36	36
	S	50			50*	50	50	50	50	50	50	50	
	H	70			70*	70	70	70	70	70	70	70	
	L	120			120*	120	120	120	120	120	120	120	
	V	200			200*	200	200	200	200	200	200	200	
T5	N	36	400 630				36*	36	36	36	36	36	36
	S	50					50*	50	50	50	50	50	
	H	70					70*	70	70	70	70	70	
	L	120					120*	120	120	120	120	120	
	V	200					200*	200	200	200	200	200	
T6	N	35	630 800 1000						35*	35*	35	35	35
	S	50							50*	50*	50	50	50
	H	70							70*	70*	70	70	70
	L	100							100*	100*	100	100	100
S7	S	50	1250 1600								50*	50*	50
	H	65									65*	65*	65
	L	100									100*	100*	100

\* Value valid only with  $I_1$  (MCCB)  $\leq$  Ith (MCS).



# Switch-disconnectors

Supply side circuit-breaker: MCCB

Load side switch-disconnectors: OT/OETL

## MCCB - OT/OETL @ 415 V

Supply s.	Release	Load s.	OT16	OT25	OT32	OT45	OT63	OT80	OT100	OT125	OT160	OT200-400	OETL630-1600
		I <sub>cu</sub> [kA]	0.5	0.5	0.5	1	1.5	1.5	2.5	2.5	4	8 - 15	17 - 50
		I <sub>n</sub> [A] / I <sub>th</sub> [A]	25	32	40	63	80	100	115	125	200	200-400	630 - 1600
T1	TM	16	4	4	4	7	20	20	T	T	T	T	T
		20	4	4	4	7	20	20	T	T	T	T	T
		25	4	4	4	7	18	18	T	T	T	T	T
		32	4	4	4	7	18	18	T	T	T	T	T
		40	4**	4	4	7	18	18	T	T	T	T	T
		50		4**	4	6	18	18	T	T	T	T	T
		63			4**	6	18	18	T	T	T	T	T
		80				6**	16	16	T	T	T	T	T
		100					16**	16	T	T	T	T	T
		125						16	T	T	T	T	T
		160					16**	T**	T	T	T	T	
T2	TM	16	20	20	20	50	T	T	T	T	T	T	T
		20	14	14	14	36	T	T	T	T	T	T	T
		25	12	12	12	25	70	70	T	T	T	T	T
		32	12	12	12	25	70	70	T	T	T	T	T
		40	12**	10	10	20	36	36	T	T	T	T	T
		50		10**	10	20	36	36	T	T	T	T	T
		63			10**	20	36	36	T	T	T	T	T
		80				7**	16	16	50	50	T	T	T
		100					16**	16	50	50	T	T	T
		125						16	50	50	T	T	T
	160						16**	50**	50	T	T	T	
	EL	25	10	10	10	16	50	50	T	T	T	T	T
		63	8*	8*	8*	12	30	30	T	T	T	T	T
		100		8*	8*	6*	16*	16	50	50	T	T	T
160					6*	16*	16*	50*	50	T	T	T	
T3	TM	63			3,5**	5	8	8	25	25	T	T	T
		80				5**	8	8	24	24	T	T	T
		100					8**	8	21	21	T	T	T
		125						8**	20	20	40	T	T
		160							18**	18	36	T	T
		200								18**	36	T	T
		250								36	T	T	
T4	TM	20	8	8	8	20	T	T	T	T	T	T	T
		32	6**	6	6	12	40	40	T	T	T	T	T
		50		6**	6	12	40	40	T	T	T	T	T
		80				8**	16	16	50	50	T	T	T
		100					10**	10	19	20	100	100	T
		160						10**	19	20	100	100	T
		250								20**	100	100	T
	EL	100-320					10*	10*	19*	20*	100*	100*	T

Select the lowest value between the I<sub>cu</sub> of the circuit-breaker and the value indicated

\* Maximum setting of the overload threshold PR2xx = 1.28\*I<sub>th</sub> OTxx/OETLxx

\*\* I<sub>1</sub> = 0.7 x I



## Switch-disconnectors

Supply side circuit-breaker: MCCB

Load side circuit-breaker: OT/OETL

### MCCB - OT/OETL @ 415 V

		Load s.	OT 200	OT 250	OT 315	OT 400	OETL 630	OETL 800	OETL 1000	OETL 1250	OETL 1600
		I <sub>cu</sub> [kA]	8	8	15	15	17	17	50	50	50
Supply s.	Release	I <sub>th</sub> [A] I <sub>lu</sub> [A]	200	250	315	400	630	800	1000	1250	1600
T5	TM	320	50	50	100	100	T	T	T	T	T
		400	50**	50	100	100	T	T	T	T	T
	EL	320-630	50*	50*	100*	100	T	T	T	T	T
T6	TM	630			25	30	70	70	T	T	T
		800				28**	60**	60	T	T	T
	EL	630-800-1000		22*	22*	28*	60	60	T	T	T
S7	EL	1000					30*	30	50	50	50
		1250					30*	30*	50	50	50
		1600				20*	30*	30*	50*	50*	50

Select the lowest value between the I<sub>cu</sub> of the circuit-breaker and the value indicated

\* Maximum setting of the overload threshold  $PR2_{xx} = 1.28 \cdot I_{th} \text{ OT}_{xx}/\text{OETL}_{xx}$

\*\*  $I_1 = 0.7 \times I$

4





Due to possible developments of standards as well as of materials, the characteristics and dimensions specified in the present catalogue may only be considered binding after confirmation by ABB SACE.

1SDC007004D0204 - 12/2004  
Printed in Italy  
Tipografia

Distributed by:

Gross Automation  
1725 South Johnson Road  
New Berlin, WI 53146  
262-446-0000, FAX 262-446-0300